

# Trace Water Vapor Analysis Using Cavity Ring-down Spectroscopy, Oscillator Quartz Crystal and Impedance Sensor Technologies

**Jun Feng and Mark Raynor**

Matheson Tri-Gas Inc., Advanced Technology Center  
Longmont, Colorado 80501

[mraynor@matheson-trigas.com](mailto:mraynor@matheson-trigas.com)

Presented at Pittcon 2009, Chicago, IL, Specialty Gas Session, Tuesday March 10, 2009



**MATHESON  
TRI·GAS**

ask...The Gas Professionals™

# Overview of Presentation

- Introduction
- Objective
- Experimental Aspects
- Operating Principles
- Results comparing the three techniques
- Summary
- Conclusion and future developments



# Introduction

## Why Trace Water?

- Next generation of semiconductor devices requires high purity gases to meet performance criteria
- Trace water impurity measurement needed to meet purity specifications.
- H<sub>2</sub>O detection is challenging at low ppb levels
  - Adsorptive properties of water
  - Reactivity and or corrosive properties of gases
  - Strong IR absorption of many matrix gas
- Various H<sub>2</sub>O measurement approaches
  - Spectroscopic: FTIR, CRDS, TDLAS
  - Sensors: QCM, P<sub>2</sub>O<sub>5</sub> cell, Al<sub>2</sub>O<sub>3</sub> impedance
  - Other: APIMS, MS, ion mobility, chilled mirror hygrometry

# Objective

- Investigate three techniques for H<sub>2</sub>O detection in the concentration range of 0-100 ppb
  - Quartz crystal microbalance (Ametek 5800)
  - Cavity ring-down spectroscopy (Halo, Tiger Optics)
  - Al<sub>2</sub>O<sub>3</sub> impedance sensor (Hygrotrace, GE Sensing)
- Performance evaluation for
  - Detection sensitivity
  - Linearity
  - Response time
  - Long term stability
  - Application in inert and hydride gases



# Experimental Set-up



Manifold for trace water vapor measurement using Span-pac H<sub>2</sub>O generator, AMETEK 5800, CRDS and GE HygroTrace Sensor

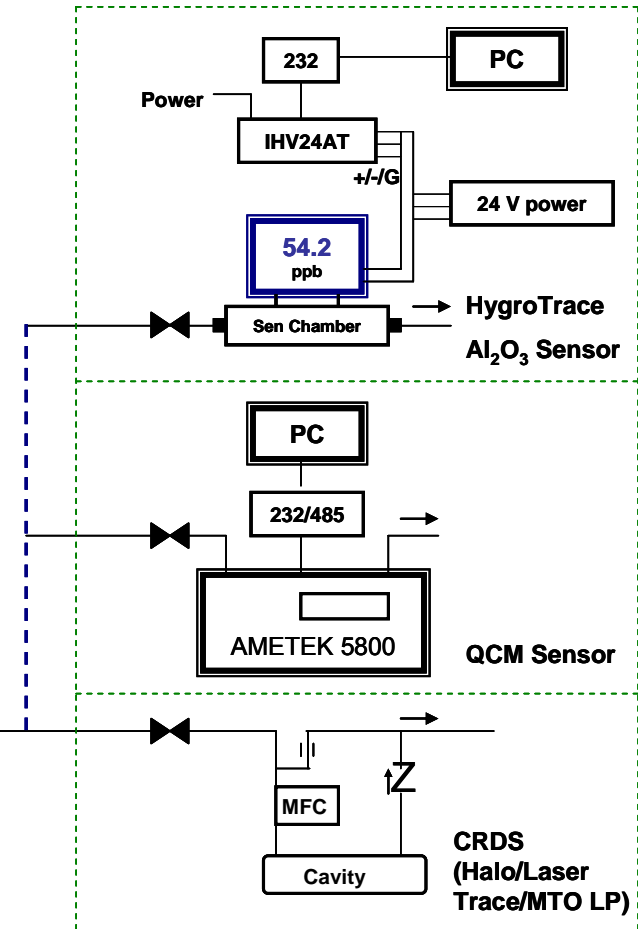
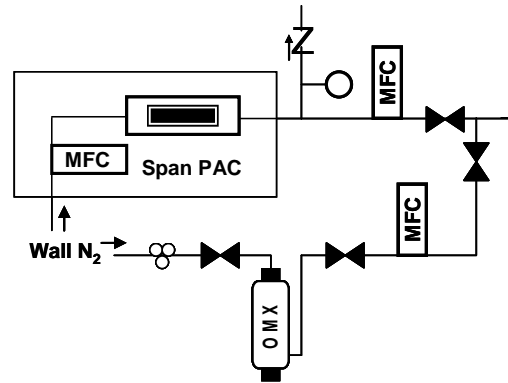

# Quartz Crystal Microbalance

Sensors based on resonating piezoelectric crystals, developed in the 1960s by researchers at ESSO Research and Engineering Co and Dupont Company.

AMETEK Inc and Shimadzu Corp. developed technology for water vapor detection in high-purity gases from ppb to ppm levels.

Sensors are coated with a hygroscopic polymer film to enhance the sensitivity for water sorption. Offers wide operating range and high detection sensitivity [1-4].

1. Sauerbrey, G., Z. Phys., 155, (1959) p 206
2. King, W. H.; Piezoelectric Sorption Detector *Anal. Chem.*, **1964**, 36 (9), pp 1735–1739
3. Guilbault, G.G: Jordan J.M Analytical uses of piezoelectric-crystals – a review *CRC Critical Rev Anal Chem* 19, 1-28 (1988)
4. Feng, J.; Raynor, M.; Owens, M.; Trace Water Vapor Detection in Pure Arsine Gas Using Quartz Crystal Oscillator Technology, Pittcon 2007 Feb 25- Mar 02 2007, Chicago

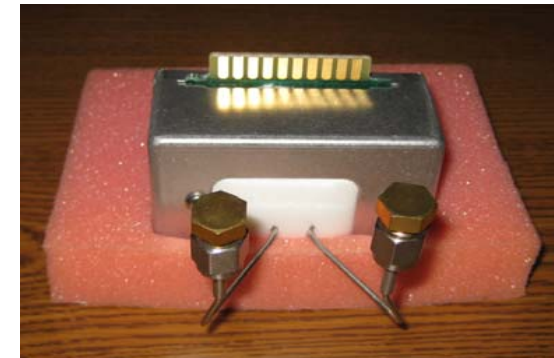
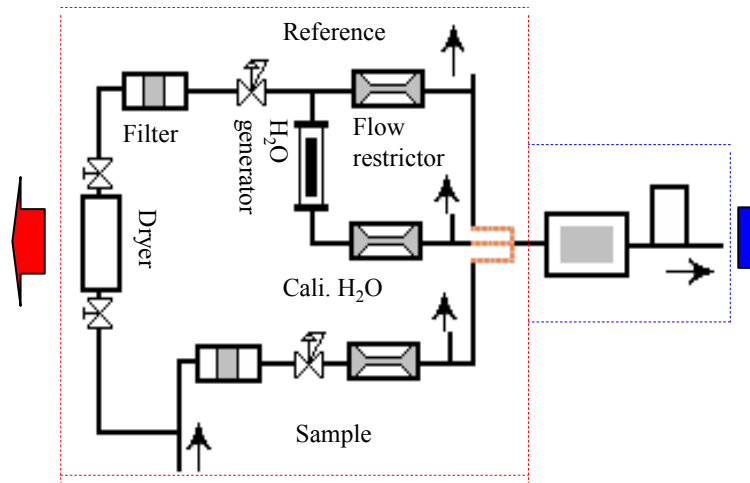

# Oscillator Quartz Crystal Analysis: Operating Principle

$$\Delta f = -C_m \Delta m$$

$\Delta f$  – change in crystal resonance frequency (Hertz) is proportional to the change in the mass per unit surface area  $\Delta m$  in grams as a result of H<sub>2</sub>O absorption

$C_m$  is a property of the crystal used based on fundamental resonance frequency, the surface area, density of the quartz and polymer properties at constant T and P

$\Delta f$  measurement relative to a reference cell compensates for temperature drifts.

By alternating flow of wet sample and dry reference gas over the crystal over a set interval,  $\Delta f$  due to H<sub>2</sub>O absorption can be determined

$$\Delta f = (f_{sample} - f_{ref.crystal}) - (f_{drygas} - f_{ref.crystal})$$

A microprocessor stores the frequencies and based on the amount of accumulated H<sub>2</sub>O during the sampling interval, calculates the H<sub>2</sub>O concentration using a polynomial expression obtained from prior calibration.



**MATHESON  
TRI-GAS**

ask...The Gas Professionals™

# Trace H<sub>2</sub>O Addition into Ametek 5800

H<sub>2</sub>O measurement with  
H<sub>2</sub>O step-addition in N<sub>2</sub>

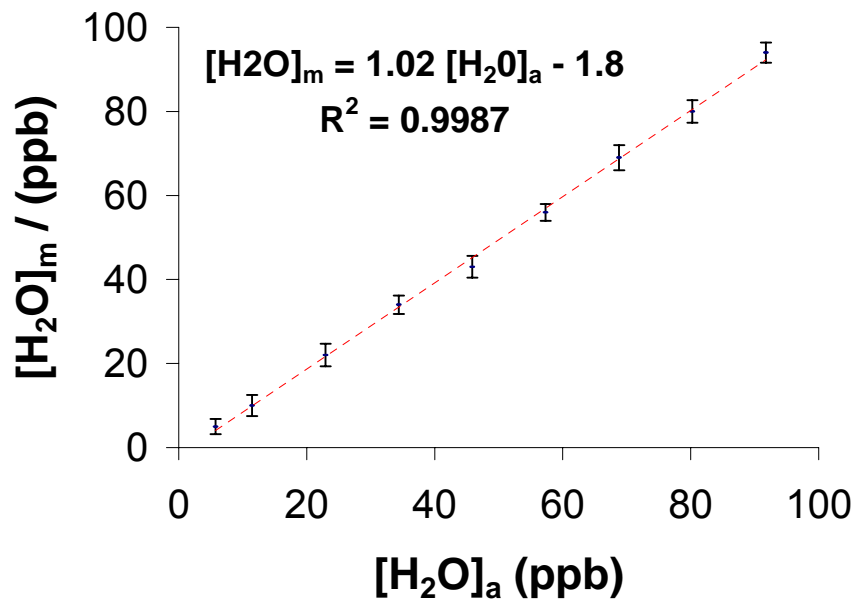
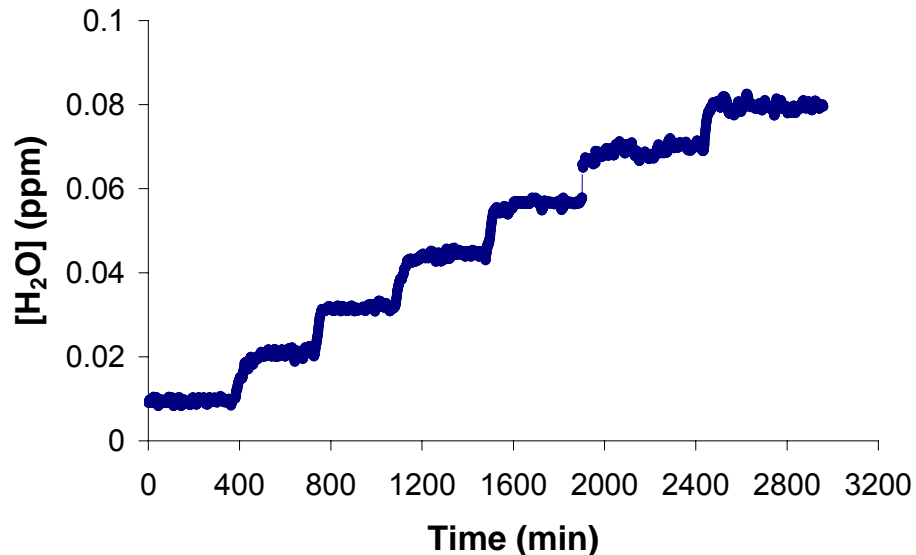

Linearity and  
correlation between  
H<sub>2</sub>O measured and  
H<sub>2</sub>O added in N<sub>2</sub>



# Ametek 5800: Response to Changes in Trace H<sub>2</sub>O

**Water vapor wet-up response in N<sub>2</sub>: Ametek took 47 minutes to reach 95% of the final value for the step 44.6 – 55.4 ppb**

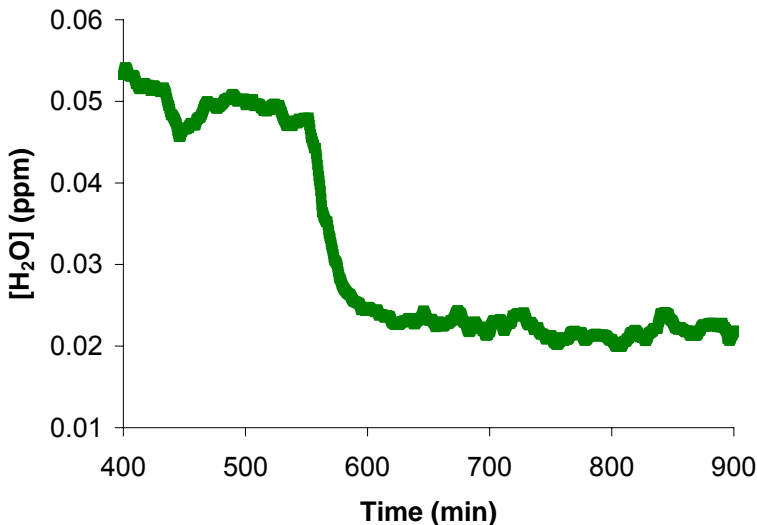
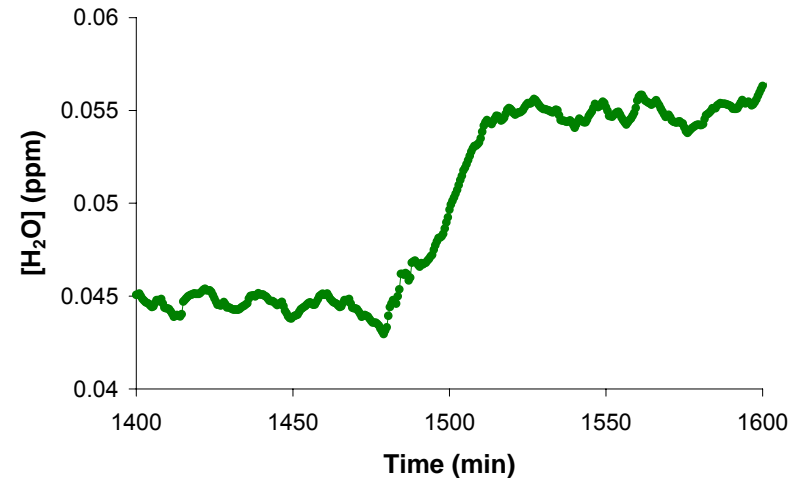

**Water vapor dry-down in N<sub>2</sub>: Ametek took 72 minutes to reach 95% of the final value for the step 49.8 – 23.2 ppb**



**MATHESON  
TRI-GAS**  
ask...The Gas Professionals™

# Ametek 5800: Trace Water Vapor Measurement Stability Test in N<sub>2</sub>

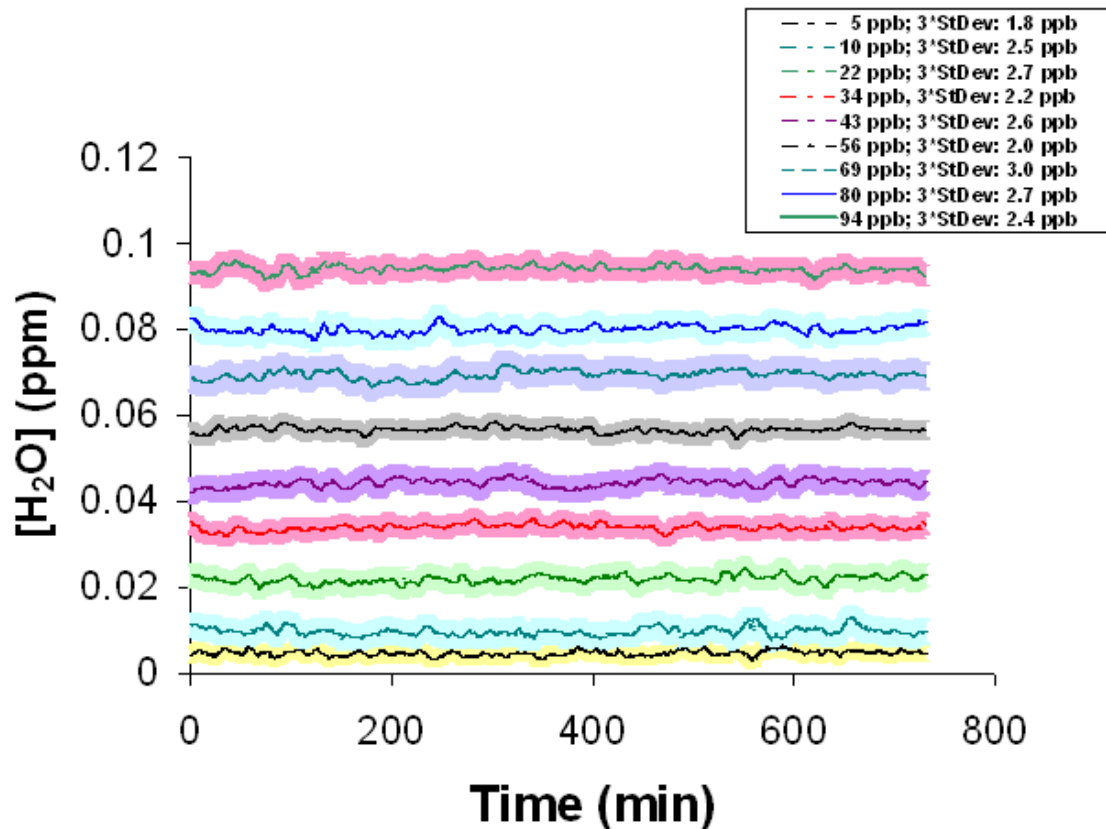

- Sensitivity is 2.4 ppb (average over 0-100 ppb range)
- Detection limit ~5 ppb in Nitrogen
- MDL dependent on dryness of the reference stream



**MATHESON  
TRI-GAS**  
ask...The Gas Professionals™

# Trace H<sub>2</sub>O Analysis in Phosphine

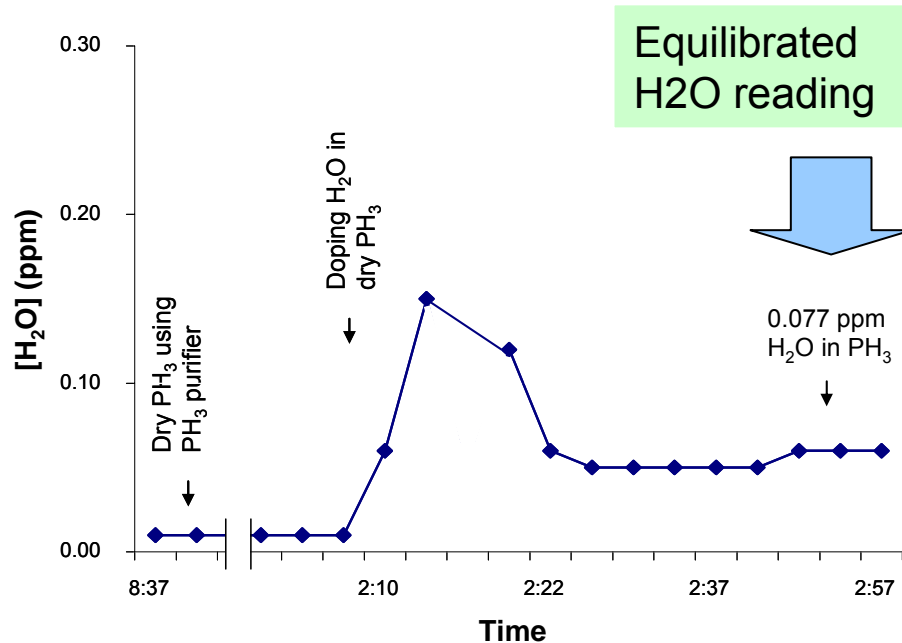

Trace water vapor doping into dry PH<sub>3</sub> using Nanochem PHX purifier

- QCM technology shows capability for measuring [H<sub>2</sub>O] in gases such as PH<sub>3</sub>, based on frequency difference of sample gas and reference gas line.
- Reference based method
- Issues observed with switching between N<sub>2</sub> and PH<sub>3</sub> references due to equilibrium of purifier
- Difficulties experienced with use of different reference matrix to sample matrix due molecular weight difference.
- Sensor lifetime also affected by gases such as phosphine



**MATHESON  
TRI-GAS**  
ask...The Gas Professionals™

# Cavity Ring-down Spectroscopy

- Cavity ring-down spectroscopy (CRDS) [1] developed since late 1980s.
- CRDS uses narrow-frequency, tunable laser diodes with ultra-high finesse optical cells to provide highly spectral resolution ( $0.0001 \text{ cm}^{-1}$ )
- The high-reflectivity of the mirrors in the optical cavity results in an effective path length of over 40 km, which enables trace water vapor detection in nitrogen to ppt levels [2].
- Trace water measurements demonstrated in high-purity process gases, such as  $\text{N}_2$ ,  $\text{HCl}$ ,  $\text{HBr}$ , arsine and phosphine [3].



1. Okeefe, A Rev Sci. Instruments 59, 2544 (1988);
2. Dudek JB, Tarsa PB, Velasquez A, Wladyslowski M, Rabinowitz, P, Lehmann KK Anal Chem 75, 4599-4605 (2003);
3. Feng J, Raynor M Chen Y, *Compound Semiconductor* 13, 31 (2007)

# CRDS: Operating Principle

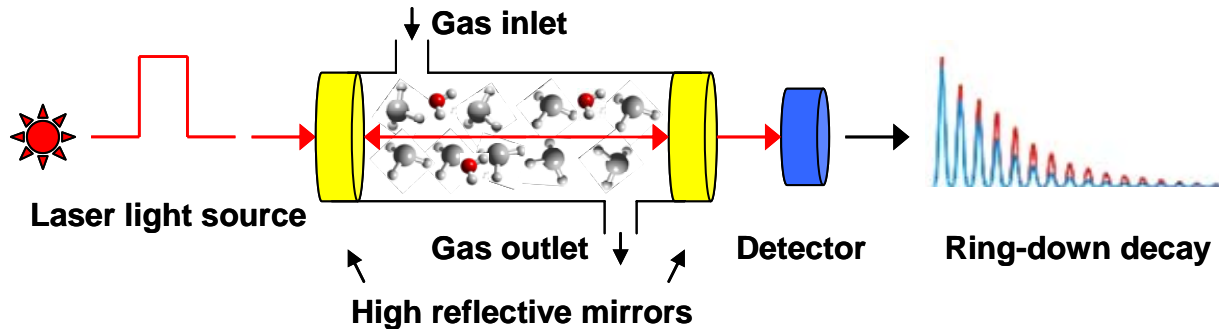

- Light is reflected by the mirrors, leaking out a tiny amount upon each reflection.
- Ring-down signal measured when the light is abruptly turned off. The decay constant increases when light is additionally absorbed by H<sub>2</sub>O in the cavity
- Ring-down time of the sample,  $\tau(\nu)$  is measured at a strong H<sub>2</sub>O absorption line
- The reference ring-down time  $\tau_0$  is measured where there are no absorptions
- The H<sub>2</sub>O concentration is calculated using:

$$1/\tau(\nu) - 1/\tau_0 = c s(\nu) N$$

where:  $c$  = speed of light  
 $s(\nu)$  = absorption cross section of molecules that absorbs light at frequency  $\nu$   
 $N$  = number density (concentration)

# Trace H<sub>2</sub>O Step-Addition into CRDS

H<sub>2</sub>O measurement as H<sub>2</sub>O challenge is increased in steps from 3 ppb to 100 ppb

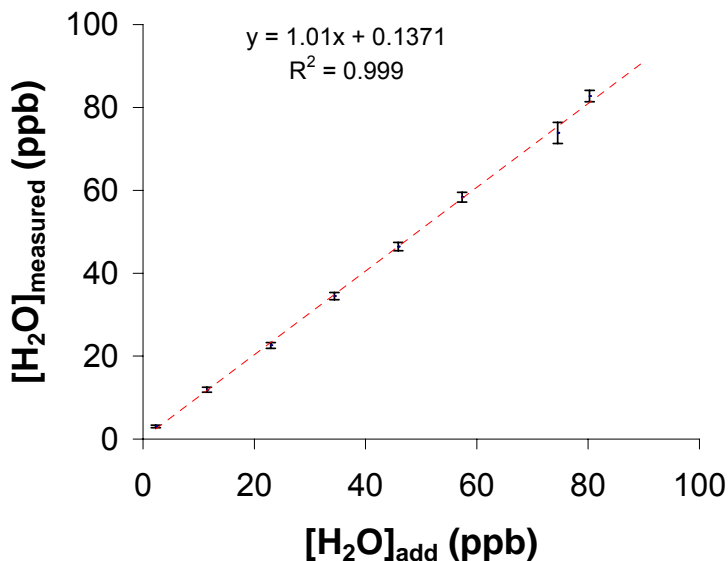
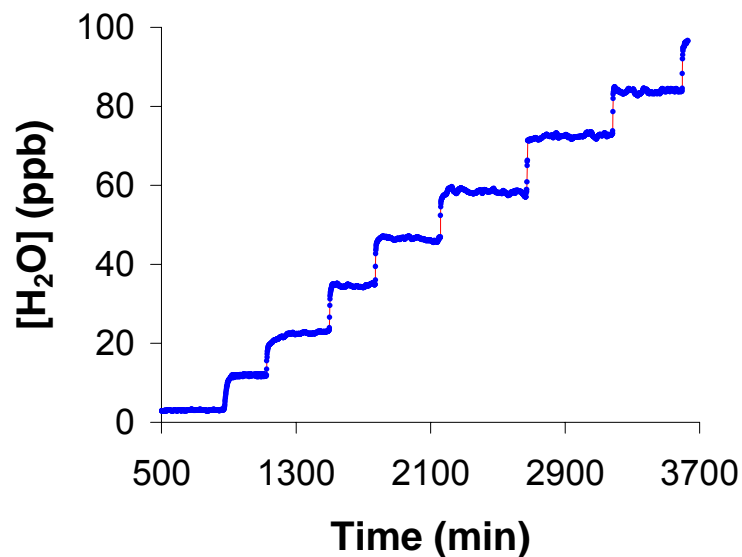

Correlation of H<sub>2</sub>O measured by Halo CRDS versus H<sub>2</sub>O added in nitrogen

# CRDS Response to Changes in Trace H<sub>2</sub>O

Wet-up test in N<sub>2</sub>: Halo CRDS measured 95% of the step from 23 ppb to 34.6 ppb in 15 min

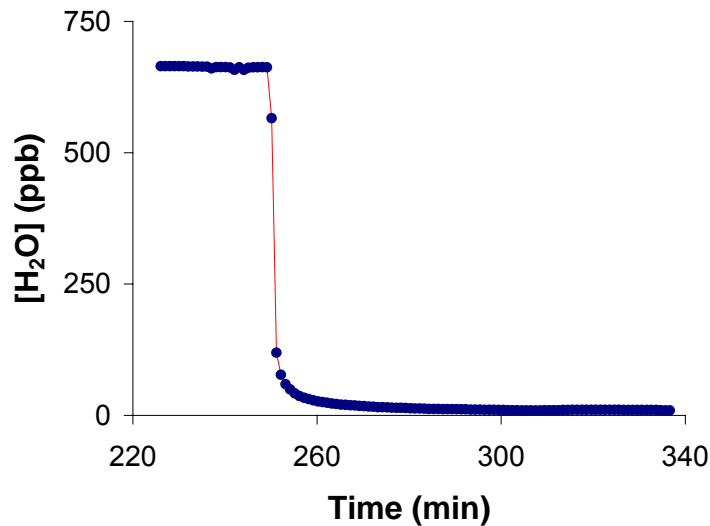
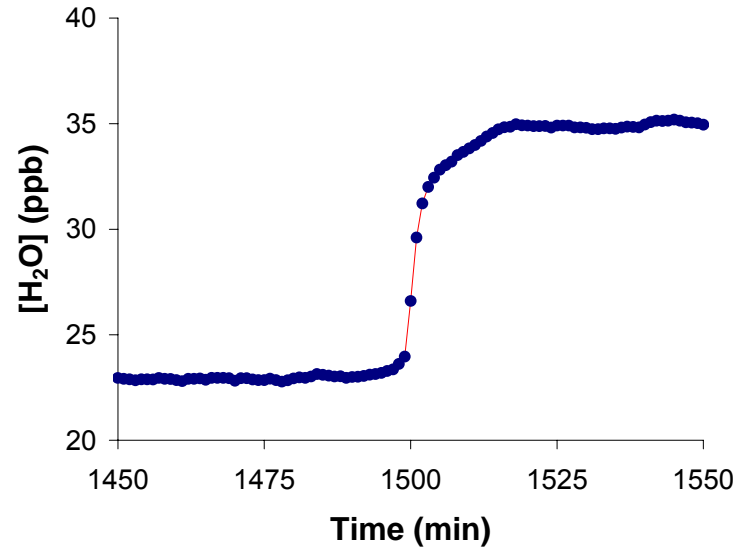

Dry-down in N<sub>2</sub>: Halo CRDS took 8 min to reach 95% of the step from 664 ppb to 0 ppb

# Stability of H<sub>2</sub>O Measurements

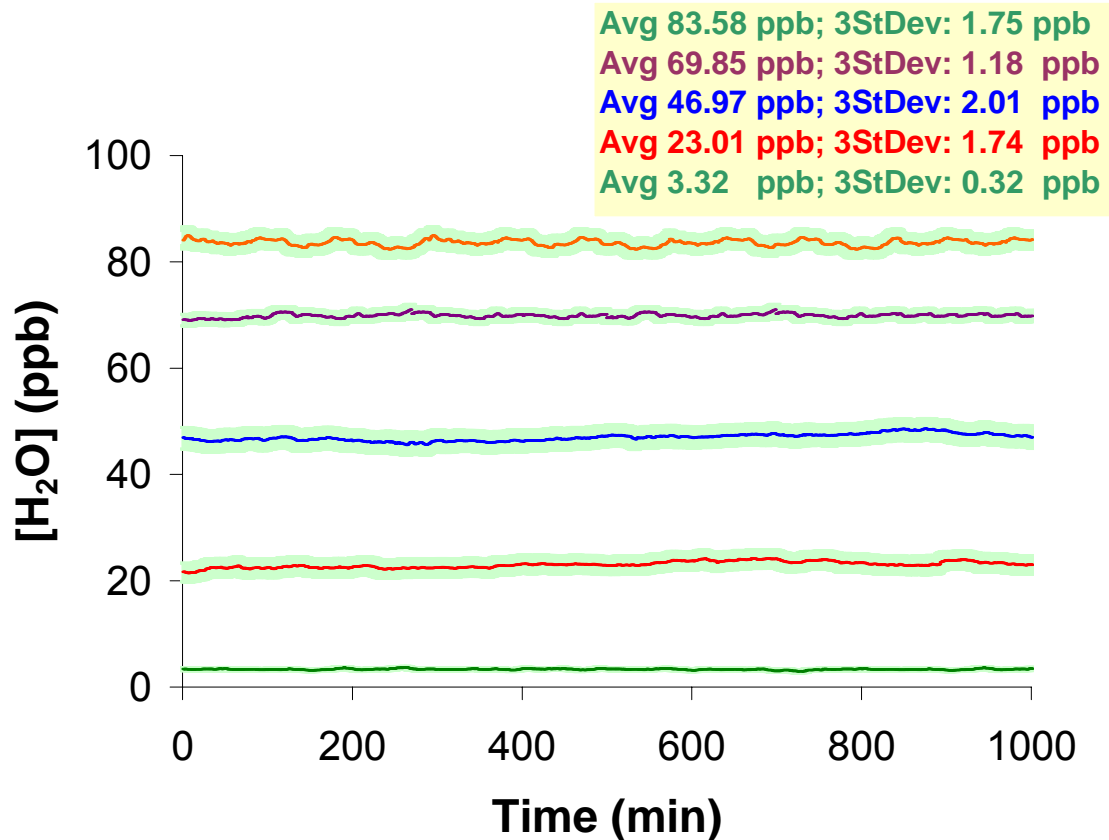

- Sensitivity is 1.4 ppb (average over 0-100 ppb range)
- Detection limit <2 ppb in Nitrogen



**MATHESON  
TRI·GAS**  
ask...The Gas Professionals™



# Trace H<sub>2</sub>O Detection in PH<sub>3</sub> with CRDS MTO-LP

H<sub>2</sub>O has a strong absorption that is sufficiently removed from those of PH<sub>3</sub> to allow detection between 1300-1400 nm at 100 torr

Spectra opposite show: 120 ppb water in N<sub>2</sub> (Red); dry PH<sub>3</sub> (Blue); and 1.5 ppm water in PH<sub>3</sub> (Green)

Sensitivity is 1.3 ppb based on 3std dev of the intercept, for a weighted linear fit.

CRDS response is linear in measured range

Zero offset of 9 ppb is due to the overlapping of PH<sub>3</sub> and residual water background that cannot be distinguished.

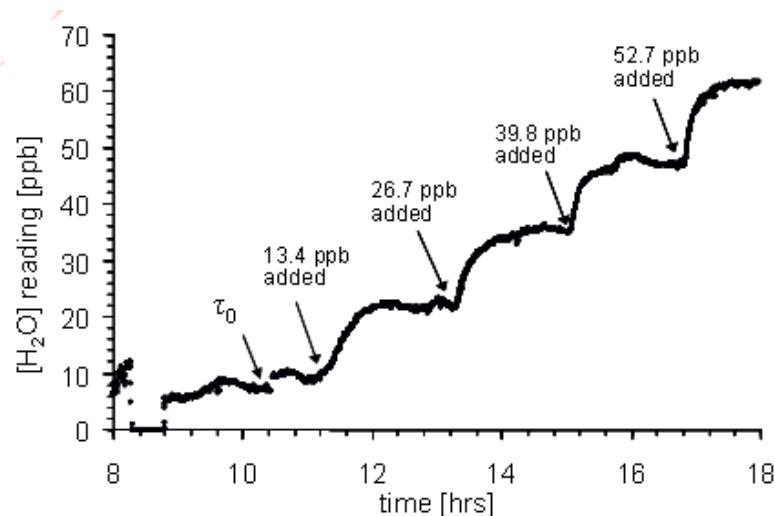
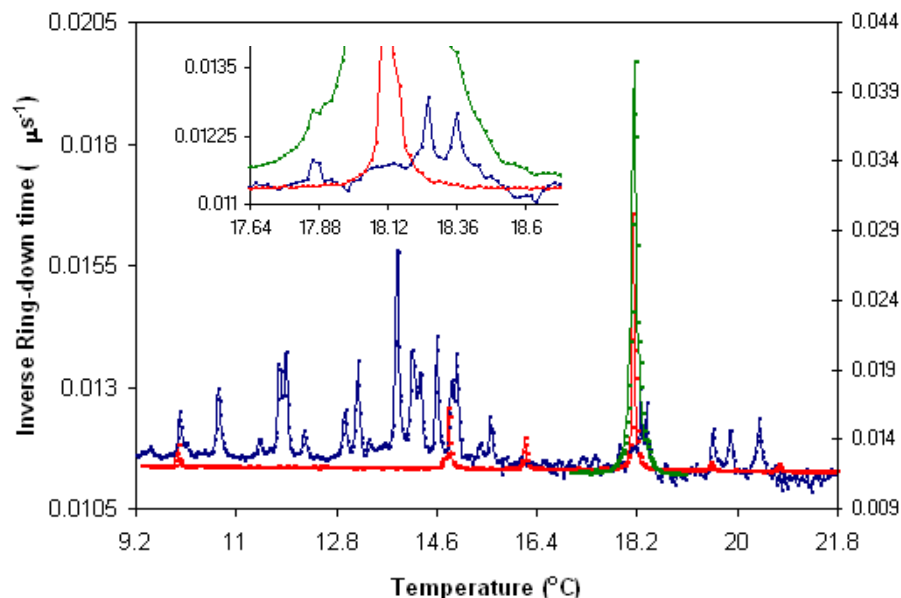

# Al<sub>2</sub>O<sub>3</sub> Moisture Sensor

- Alumina first proposed for H<sub>2</sub>O sensing in 1930s and applied in early 1950s [1-2].
- Based on the correlation of the capacitance / impedance with H<sub>2</sub>O adsorption on an Al<sub>2</sub>O<sub>3</sub> film. Offers wide measurement range, minimal effects of P and T.
- Technology traditionally suffers from slow response time [3] due to the intrinsic adsorption/desorption properties of this material

Photograph of Probe Assembly

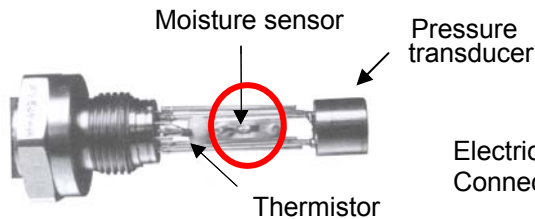

Front View of Al<sub>2</sub>O<sub>3</sub> Sensor

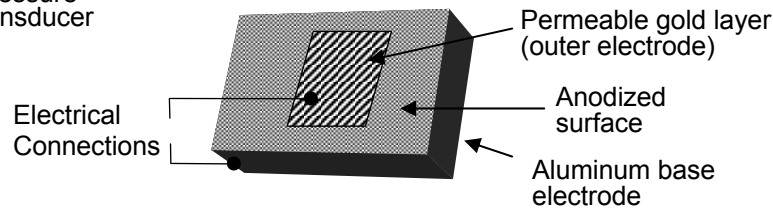

Cross-sectional View

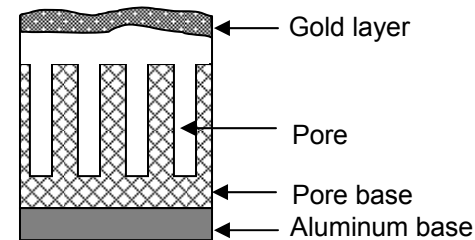

Impedance Model

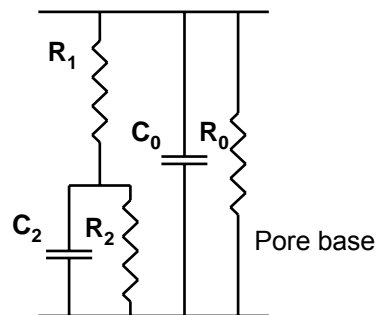

$$C = \epsilon\epsilon_0 \frac{A}{d}$$

$$\epsilon_0(\text{vacuum}) = 8.85 \times 10^{-12} \quad F / m$$

$$\epsilon(H_2O, 20^{\circ}C) = 80.4$$

$$\epsilon(Al_2O_3) \approx 9.3$$

1. Taylor, H.S.; Gould, A.J. *J. Am. Chem. Soc.*, 1934, 56 (8), 1685-1687
2. Weaver, E. R. *Anal. Chem.*, 1951, 23 (8), 1076-1080
3. Basu, S. et al., *Sensor and Actuators B* 79, 182-186 (2001)



**MATHESON  
TRI-GAS**

ask...The Gas Professionals™

# New Development in Al<sub>2</sub>O<sub>3</sub> Sensors

- Al<sub>2</sub>O<sub>3</sub> based H<sub>2</sub>O sensor with integrated heating element that periodically cycles the temperature developed by GE Sensing [1].
- A temperature pulse is applied to 'dry down' the sensor. Then the sensor is allowed to cool down and the H<sub>2</sub>O measurement is made based on the wet-up slope and resulting change in impedance

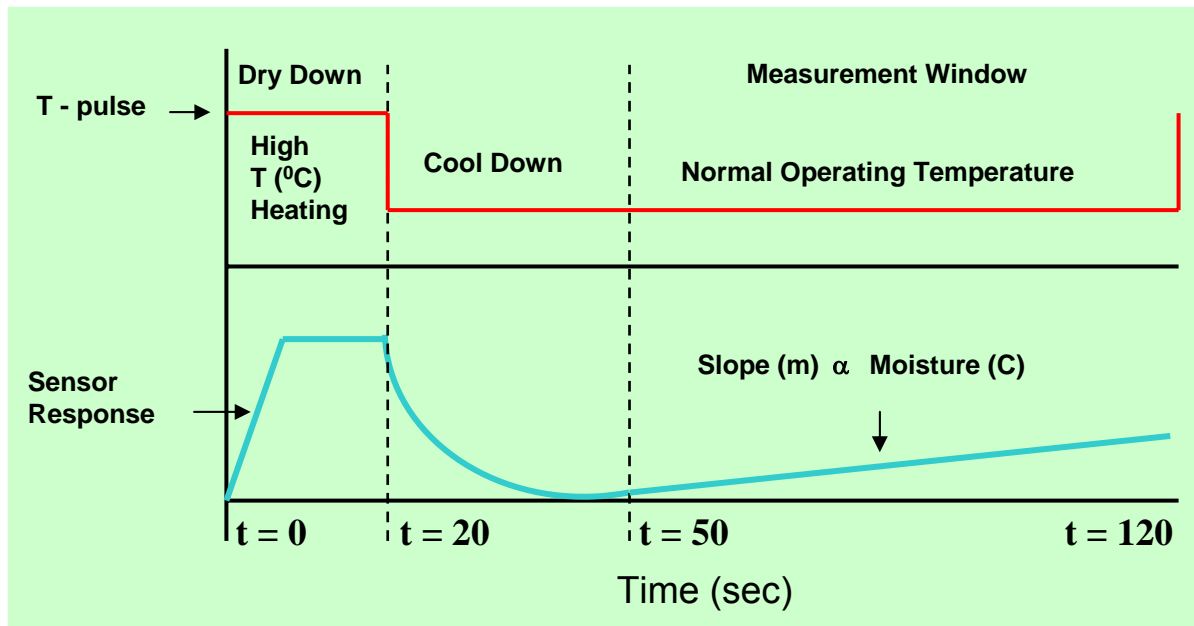

$$Z(f) = R(f) + jX(f)$$

Z: impedance;  
R: resistance;  
X: reactance;  
f: frequency

1. Kerney, J. New Method for Trace Moisture Measurement, Advances in Wafer Processing, SEMICON West, San Francisco, California, July 2007
2. Kerney J, ISA 53<sup>rd</sup> Analysis Division Symposium, Houston TX, 2008



GE HygroTrace Moisture Sensor

# Trace H<sub>2</sub>O Addition and Response of HygroTrace Sensor

H<sub>2</sub>O measurement with H<sub>2</sub>O step addition into purified N<sub>2</sub> from 15 ppb to 93 ppb

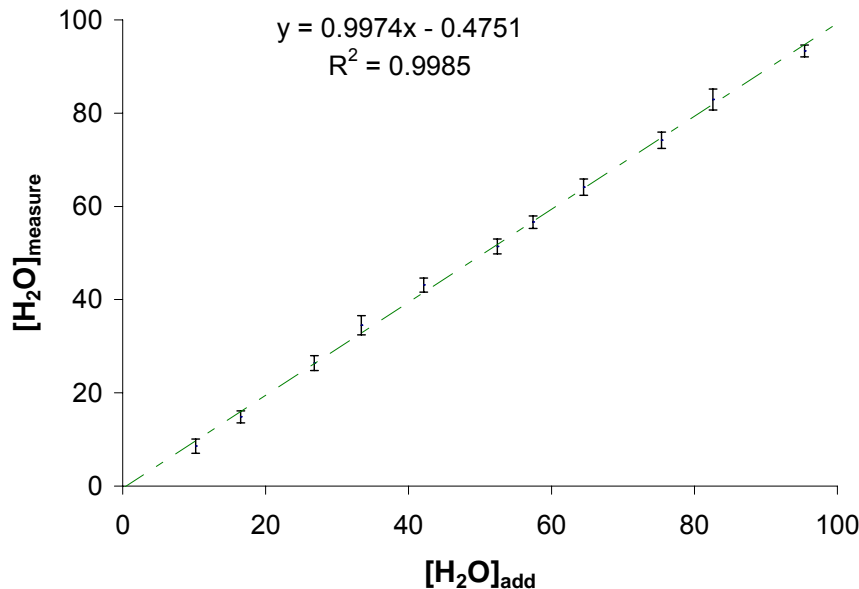
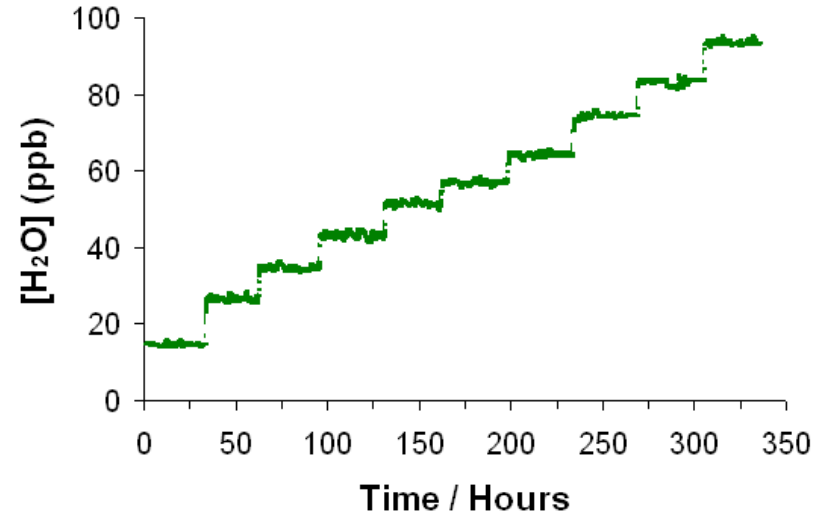

Correlation of H<sub>2</sub>O measured and H<sub>2</sub>O added



# Response of HygroTrace Al<sub>2</sub>O<sub>3</sub> Sensor to changes in H<sub>2</sub>O

Wet-up Test in PN<sub>2</sub>  
HygroTrace sensor took 13 min to reach 95% of the final value during the step from 15 ppb to 26 ppb

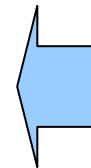
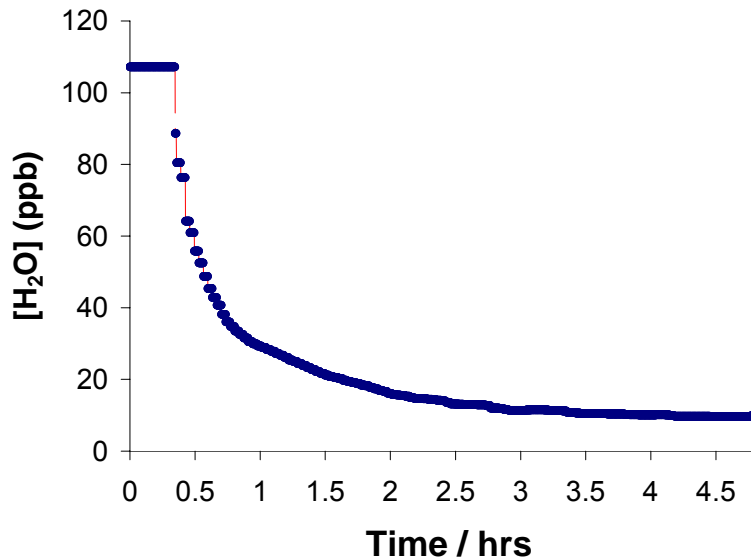
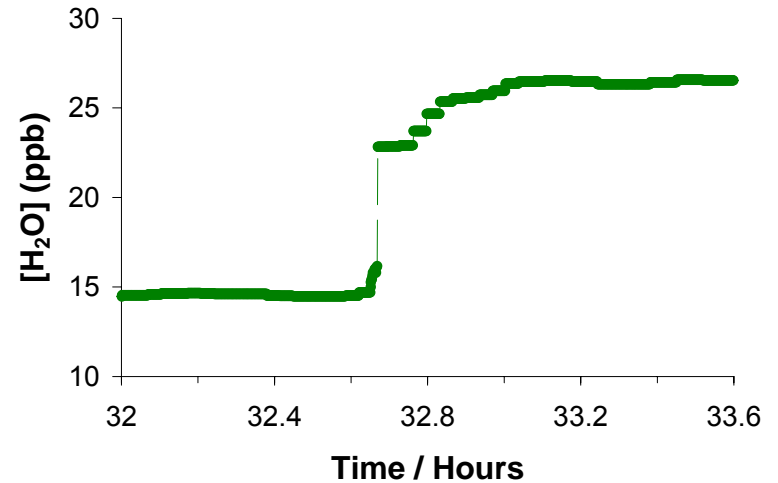
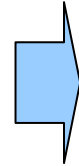

Dry-down Test in PN<sub>2</sub>  
HygroTrace Sensor took 108 min to reach 95% of the final value during the step from 107 ppb to 10 ppb

# Stability of H<sub>2</sub>O Measurements with HygroTrace Al<sub>2</sub>O<sub>3</sub> Sensor

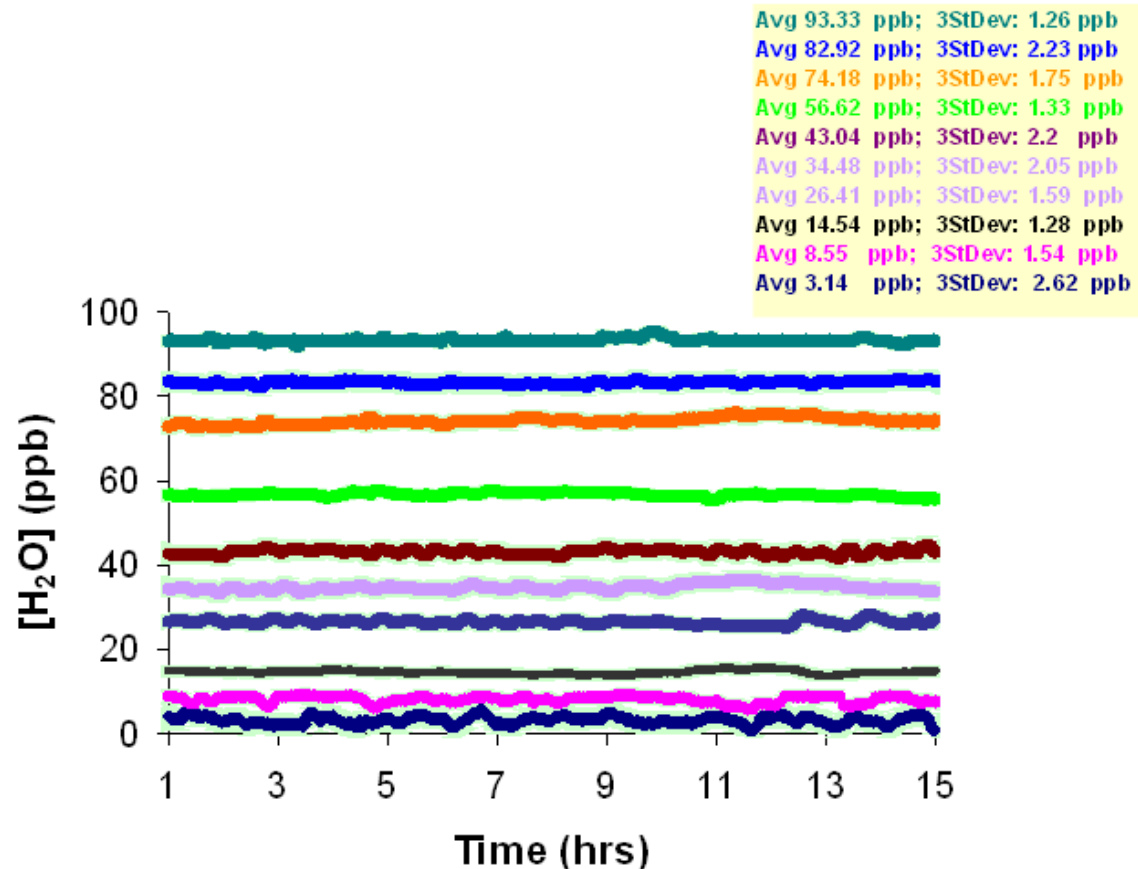

- Sensitivity is 1.8 ppb (average over 0-100 ppb range)
- Detection limit ~3 ppb\* in Nitrogen (initial 3 months)
- After this DL increased to 10 ppb



# Trace Water Vapor in Ultima PH<sub>3</sub> Cylinder Using HygroTrace Sensor

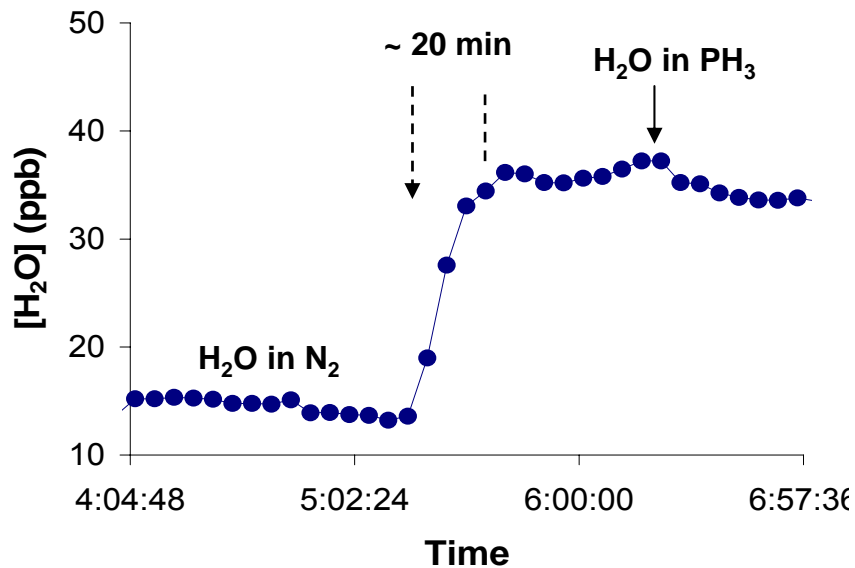

**HygroTrace Measurement**

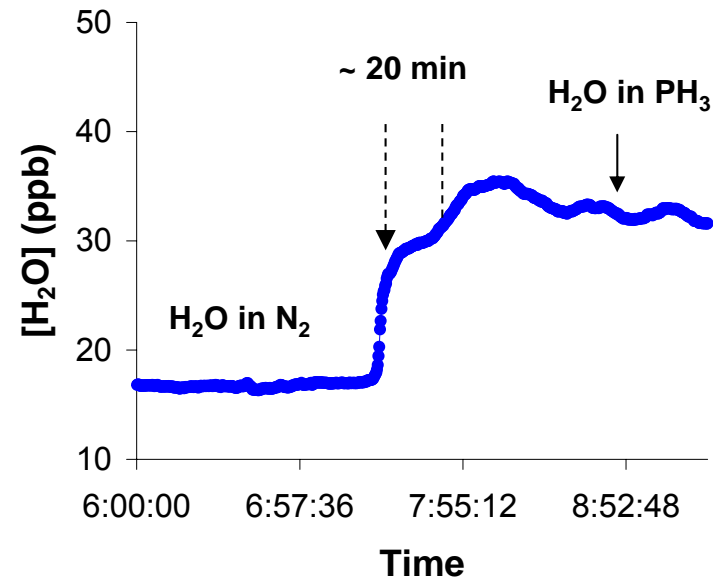

**CRDS Measurement**

- Preliminary study shows trace H<sub>2</sub>O detection feasibility of Hygrotrace Al<sub>2</sub>O<sub>3</sub> sensor in PH<sub>3</sub> versus established CRDS method

# Summary of Findings

Parameter	Ametek 5800 QCM	Halo CRDS	HygroTrace Al <sub>2</sub> O <sub>3</sub> Sensor
$R^2$ ( $[H_2O]_{\text{measured}} \sim [H_2O]_{\text{added}}$ )	0.998	0.999	0.9985
Sensitivity (Average 3*StDev from 0-100ppb)	2.4	1.4	1.8
Detection limit ppb (in N <sub>2</sub> )	~ 5	< 2	~ 10
Wet-up ppb / min	(44.6 → 55.4) / 47	(23 → 34.6) / 15	(15 → 26) / 13
Dry-down ppb / min	(49.8 → 23.2) / 72	(664 → 10) / 8	(107 → 10) / 108
Stability test / min	> 700	> 1000	> 900



# Future Development Trends

## Mass-based Sensors

- QCM based sensor: AMTEK moisture analyzer Model 5910 UHP has 100 pptv detection sensitivity and 150 pptv detection limit in inert gases [1];
- CNT mass-based sensor enable potentially ultra-high sensitivity of  $10^{-21}$  g [2].

## Laser Spectroscopy

- CRDS, prism CRDS, CEAS [3] , and quantum cascade laser absorption [4] technologies

## Electrical Impedance-based Sensor

- Carbon nanotubes may provide new solutions for trace water vapor detection and push sensitivity and detection limits to new levels for electrical impedance measurements.

1. <http://www.ametekpi.com/moisture-analyzers/AMETEK-5910UHP-Moisture-Analyzer.pdf>
2. Li, Y.; Qiu, X.M.; Yang, F. et.al.; Nanotechnology 19 (2008) 165502
3. Ye, J. et.al.; Science 311, 1595-1599(2006)
4. Provencal R, Gupta M, Owano TG, et al. Applied Optics 44,6712-6717(2005)

- Thank you for attending this presentation
- Please visit the Matheson Tri-Gas Booth in the Exhibition Hall (Booth # 1455) with any questions or for a hardcopy of the slides