

Cross Beam Ionizer Design for Plasma Monitoring

Extrel CMS, Quadrupole Mass Spectrometry, 575 Epsilon Drive, Pittsburgh, PA 15238

(Poster Presented at the 1996 AVS Conference in Philadelphia, PA, October 16, 1996)

In order to accurately characterize plasma, you need to obtain a representative sample. Sampling the plasma as a molecular beam through rapid pressure reduction immediately after ions, radicals and neutrals leave the plasma, allows for an unadulterated snapshot of the plasma chemistry. With molecular beam sampling, you are looking directly at the chemical soup which comprises the plasma. This includes noise sources such as photons, electrons, metastable neutrals, and even particulates in addition to the ions, neutrals and radicals to be monitored. A cross beam ionizer allows for the separation of the analyte signal, which is comprised of plasma ions and ions created in the ionizer from plasma molecules and neutrals, from these sources of noise. We have developed a high sensitivity cross beam ionizer with integral energy analyzer which offers a dramatic increase in signal-to-noise over axial conventional ionizers, while protecting the quadrupole analyzer and detector from direct bombardment with the reactive species common to plasmas used in semiconductor applications. This presentation will include the results of our experimental characterization of this ionizer.

I. Sampling a Chemical Soup:

There are a wide variety of species present in a high pressure source such as a plasma: Metastable neutrals; Radicals; Positive Ions; Negative Ions; Electrons; Photons; Clusters and Particulates.

A plasma monitoring system must allow selective monitoring of these various species, without interference from the others.

In order to obtain a representative sample, a molecular beam can be generated through rapid pressure reduction to a collision-free vacuum level.

The resulting molecular beam will thus contain an unadulterated sample which truly represents the plasma itself.

When only a single stage of pressure reduction is used, the output of the ionizer will contain some of the true Molecular Beam, but will be dominated by Scattered Used-to-be-Beam.

In a Two Stage Molecular Beam (Figure 1), only the unadulterated beam sample is allowed into the ionizer. Scattered Used-to-be-Beam is pumped away in the first pumping stage.

Figure 2 illustrates a typical two stage molecular beam plasma sampling system.

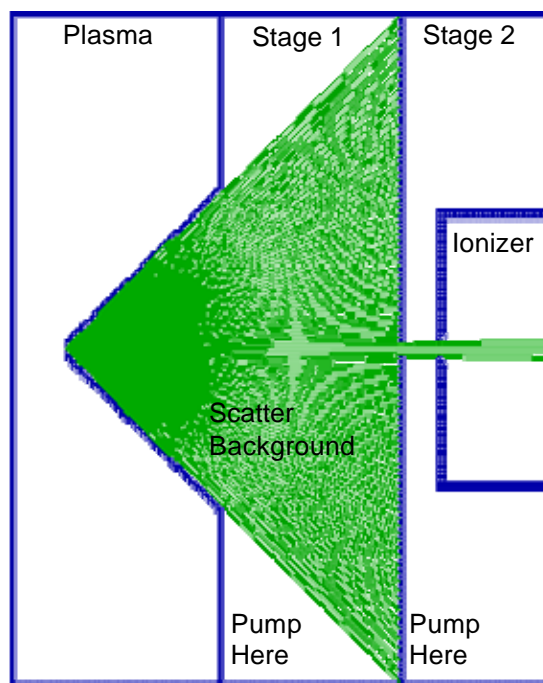

Figure 1. Two Stage Molecular Beam Sampling System.

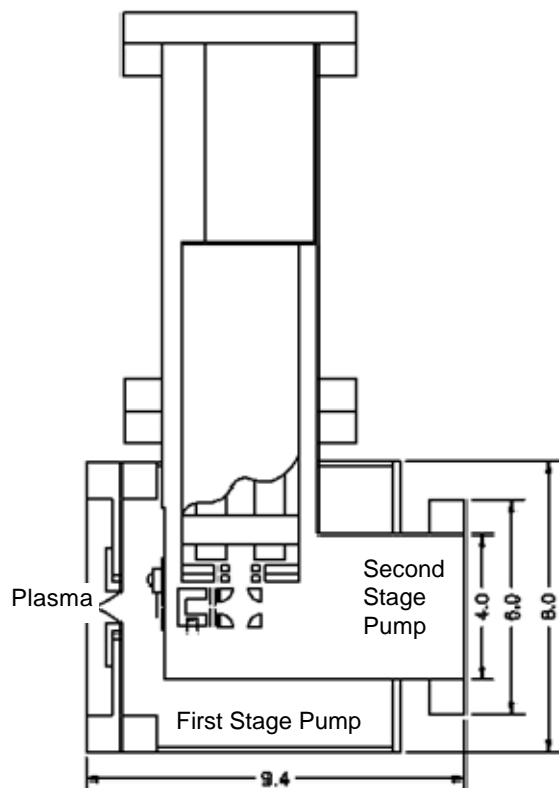

Figure 2. Plasma Monitoring with a Two Stage Molecular Beam Sampling System, using a Cross Beam Deflector Ionizer. (All dimensions are in inches.)

II. Why Use a Cross Beam Ionizer?

Improved Signal-to-Noise:

Photons and energetic ions can cause noise if in line-of-sight with the detector.

Reduced Contamination:

Condensables and particulates never see the off-axis mass filter and detector, and therefore cannot contaminate them.

Improved Pumping:

With an Axial Molecular Beam Ionizer, most of the pumping load of a molecular beam must be pumped through limited conductance holes in the mass filter housing itself.

With the Cross Beam Deflector Ionizer, there is virtually infinite pumping speed for the beam exiting the ionizer, limited only by the size of the pump.

III. How Does the Cross Beam Deflector Ionizer Work?

The Cross Beam Deflector Ionizer combines the high sensitivity ionization region of an Axial Molecular Beam Ionizer with a high transmission Quadrupole Deflector Energy Analyzer.

Ions generated in a gold mesh ion region are extracted and injected into a Quadrupole Deflector Energy Analyzer where they are deflected ninety degrees into a Quadrupole Mass Filter.

Photons, metastables, particulates, and molecular beam gases which were not ionized, pass through the Quadrupole Deflector to a pump or cold finger.

In contrast to a quadrupole mass filter, ions are injected 'sideways' into a Quadrupole Deflector, perpendicular to the pole axis. Similar to a quadrupole mass filter, opposite pairs of rods are electrically connected, but to DC power supplies of opposing polarities.

The Quadrupole Deflector is an energy analyzer. The potential difference between these pairs of rods determines the energy band pass, and the average of these potentials determines the center point of the band pass.

Figure 3 illustrates the calculated trajectories of ions created in the ion source (A), extracted into the quadrupole deflector (B - negatively biased poles, C - positively biased poles) which focuses the ion beam into a quadrupole mass spectrometer (D). Deflector voltages were -300 and +44 volts.

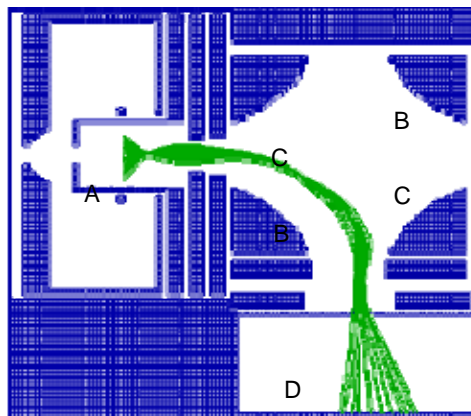
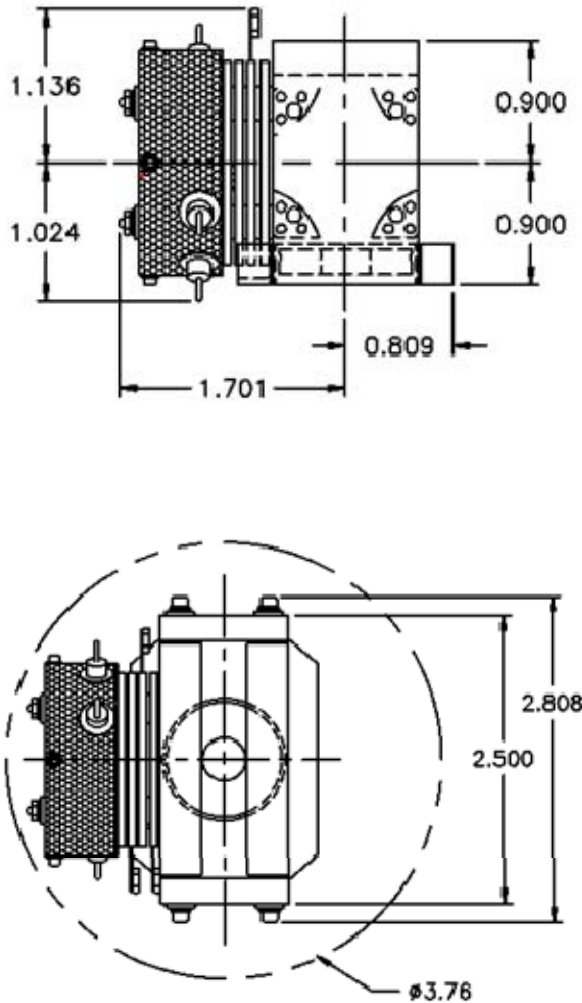

Figure 3. SIMION Simulation of Cross Beam Deflector Ion Trajectories

Figure 4 contains dimensional drawings of the Cross Beam Deflector Ionizer. The Production Model's dimensions differ. See Addendum.

voltages gets wider as the Negative Pole is maintained further from ground. For drift-free tuning, it is recommended that the negative pole be maintained in the -150 to -400 volt range.



Optimum Tune Values for m/z 28 (in volts)

Ion Region	+8	+8	+8	+8
Extraction Lens	+11	+9	+6	+4.5
Negative Pole Pair	-400	-200	-50	-5
Positive Pole Pair	+55	+30	+16	+10
Quadrupole Entrance Lens	-10	-10	-50	-100

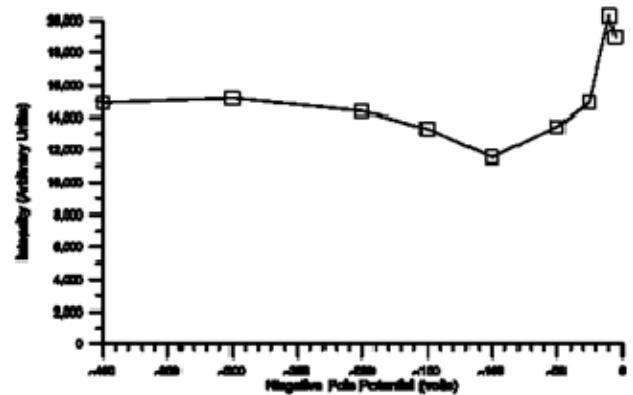

Figure 5. Intensity measured as a function of Negative Pole Potential. System was re-tuned for sensitivity at each set point.

Figure 4: Prototype Cross Beam Deflector

Ionizer Dimensions. Production Unit Dimensions Differ.

IV. Tuning Characteristics

The tuning of the Cross Beam Deflector Ionizer is straightforward. For every Negative Pole Pair set point, there is an optimum Positive Pole Pair set point. The Quadrupole Deflector entrance and exit lens potentials are derived from the pole potentials via a vacuum compatible voltage divider. The Extraction Lens and Quadrupole Mass Filter Entrance Lens voltages have a slight dependence on the deflector pole set points.

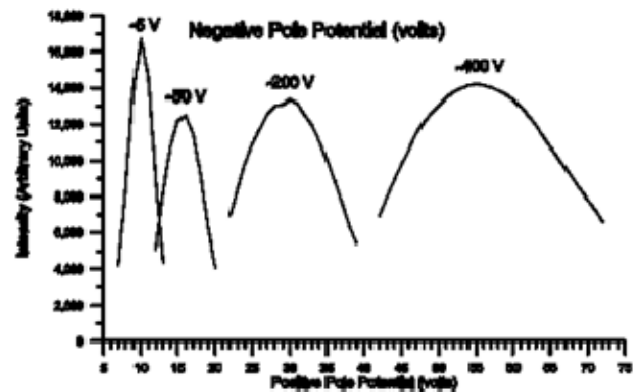

Figure 5 demonstrates that ionizer sensitivity is fairly constant over a wide range of pole voltage set points.

Figure 6 demonstrates that the tuning range for the pole

Figure 6. Positive pole tuning curves for various negative pole set points.

V. Ionizer Sensitivity

An Extrel MEXM-500 mass spectrometer system was configured to measure the sensitivity of the ionizer. This system consists of a 19 mm (3/4 inch) diameter rod quadrupole driven by a 1.2 MHz RF power supply controlled by the Merlin data system.

The absolute sensitivity for nitrogen in air was measured at m/z 28 to be greater than 12 mA/torr with baseline resolution. (See Figure 7) This is more than double the sensitivity typically seen with our standard Axial Molecular Beam Ionizer configured in a similar system.

Tune Values (in volts)	+19.0
Ion Region	+9.0
Extraction Lens	-180.0
Negative Pole Potential	+32.0
Positive Pole Potential	+10.0
Quadrupole Mass Filter Entrance Lens	0.0
Quadrupole Mass Filter Pole Bias	0.0
Quadrupole Mass Filter Exit Lens	15.0
Emission Current	

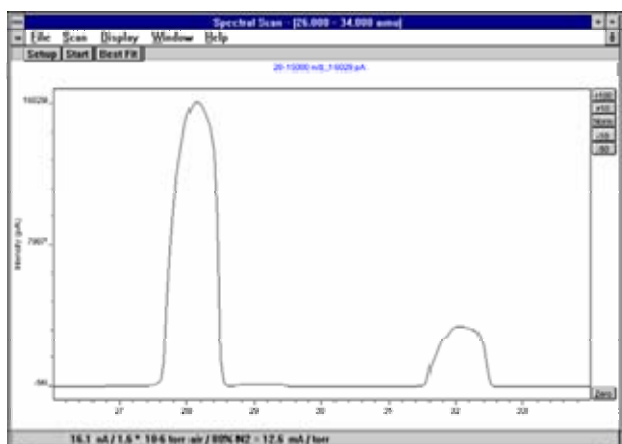

Figure 7. Faraday measurement demonstrating 12.6 mA / torr ionizer sensitivity, measured by leaking air into the vacuum chamber as a residual gas.

VI. Conclusions

Accurate sampling of a plasma requires a two-stage molecular beam. The Cross Beam Deflector Ionizer has the following features:

- High sensitivity
- Excellent signal-to-noise
- Optimized pumping of beam background.
- Broad tuning maxima's to reduce drift.
- Off-axis beam sampling to minimize contamination of quadrupole mass filter and detector.

The Quadrupole Deflector Energy Analyzer promises the capability to tune the quadrupole mass spectrometer to selectively analyze pre-formed ions over a wide range of ion energies.

VII. Addendum

The Production Model of the Cross Beam Deflector Ionizer was modified from the prototype design characterized in this Application Note. In the Production Model the distance from the molecular beam aperture to the quadrupole mass filter entrance plate is 1.269 inches versus the 0.900 inches in the prototype design shown in Figure 4.



Extrel CMS

575 Epsilon Drive Pittsburgh, Pennsylvania 15238-2838 USA
Tel: (412) 963-7530 FAX: (412) 963-6578 Web: www.extrel.com e-mail: info@extrel.com