



Model COSA 707 7 Gas Emissions Analyzer

USERS MANUAL



Emissiones gases, Límite de la ley 2	
O ₂ (%)	2.35
CO (ppm)	87
NO (ppm)	203
NO ₂ (ppm)	13
SO ₂ (ppm)	466
Tgas (°C)	325

Operation Manual –

Please carefully read and follow all instructions before operating the analyzer.

1	Table of contents	
1	TABLE OF CONTENTS	2
2	INTRODUCTION	7
2.1	The COSA 707	7
2.2	The company COSA Xentaur	7
2.3	Important general information (EN 50379) and VDI 4206	7
2.4	Important information about the users/operation manual	7
3	SAFETY INFORMATION	8
3.1	Safety regulations.....	8
3.2	Specific safety regulations	8
4	RETURNED GOODS.....	9
4.1	Return of hazardous waste.....	Error! Bookmark not defined.
5	MEASUREMENT PRINCIPAL	9
5.1	Gas flow diagram	10
5.2	Electrochemical measured principle	10
6	ANALYZER DESCRIPTION.....	12
6.1	Analyzer front.....	12
6.2	Analyzer Connectors - bottom side.....	12
6.3	Analyzer Connectors - top	13
6.4	Analyzer Back	13
6.5	Condensate separator.....	14
7	ACCESSORIES.....	15
7.1	Gas sampling probes	15
8	OPERATING THE ANALYZER	16
8.1	The Display	16
8.2	The Keypad.....	16

8.3 Menu configuration..... 17

9 FIRST USE OF THE INSTRUMENT 18

9.1 Analyzer ready for operation 18

9.2 Analyzer settings..... 18

 9.2.1 Switch-ON protection 19

 9.2.2 Setting printer type 19

 9.2.3 Bluetooth settings..... 19

9.3 Setting time and date 21

9.4 Configuration of measurement program 22

 9.4.1 Setting the CO ppm limit values 22

 9.4.2 Fuel type selection and O2 reference 23

 9.4.3 User definable fuel types 24

 9.4.4 Configuration of the measurement window (display content) 26

 9.4.5 Configuration of the zoom function 26

 9.4.6 Change measurement program names 26

 9.4.7 Select core flow search 27

10 MAINTENANCE 27

11 PREPARATION FOR EACH MEASUREMENT 27

11.1 Power supply..... 27

11.2 Auto Off..... 27

11.3 Measurement with battery charger/battery charging 27

11.4 Measurement with battery (Battery monitoring) 27

11.5 Operation temperature 28

11.6 Condensate separator..... 28

11.7 Connectors and leak tightness 28

11.8 Power ON and zeroing 29

12 HOW TO TAKE A MEASUREMENT 30

12.1 Selection of the measurement program 30

12.2 Core flow search 31

12.3 Measured Value Display..... 32

12.4 Non-continous draft measurement 33

12.5 CO purging (optional) 34

12.6 CO/H2 and BigCO (optional) 34

12.7	Test program.....	35
12.8	CO ambient.....	35
12.9	Temporary buffer.....	36
12.9.1	Set values into temporary buffer.....	36
12.9.2	To bring values back from the temporary buffer	36
12.10	Storage the measuring results	37
12.11	Printing the measurement results.....	37
12.12	End of measurement.....	37
12.13	Last measurement results.....	38
12.14	Pressure measurement.....	38
12.15	Flow measurement (optional).....	39
12.16	Differential temperature measurement.....	42
12.17	External HC detector (optional).....	42
12.17.1	Operating HC-detection	43
12.17.2	Setting alarm threshold and zero point setting	43
12.17.3	Print-out.....	44
13	DATA STORAGE	45
13.1	Organisation of the data memory	45
13.2	Information about the data memory	45
13.3	Site administration.....	45
13.3.1	View and search sites	46
13.3.2	New entry and change of sites	47
13.3.3	Delete sites	48
13.4	Data transfer via SD Card (Option).....	48
13.4.1	Import of Sites	49
13.4.2	Export of Sites	50
13.4.3	Export of Flue Gas Measurements	50
13.4.4	Export of Differential Pressure Measurements	50
13.5	Measurements in the data memory	51
13.5.1	View measurements.....	51
13.5.2	Delete measurements	52
13.5.3	Export measurements to a SD card (optional).....	52
14	EXTRAS / ADJUSTMENTS.....	53
14.1	Maintenance adjustment menu.....	53
14.2	Manufacturer default settings	53
14.3	Service values.....	54

14.4 Leak proof test 55

14.5 Contents SD card 56

14.6 Analyzer info 56

15 TECHNICAL SPECIFICATIONS 57

16 APPENDIX 59

16.1 Text input 59

16.2 Asking the user for a decision (pop up window)..... 59

16.3 Datatransfer with Bluetooth (optional)..... 60

 16.3.1 PDA-interface Bluetooth 60

 16.3.2 PC-interface Bluetooth 60

 16.3.3 Spezification..... 61

16.4 Using the USB-Port 61

16.5 Analysis and calculations 66

16.6 EG –Declaration of confirmity 66

Inspect Shipment for Damage

Carefully inspect the entire shipment for damage in the presence of the shipper's agent, removing packaging material if necessary. Note any damage to packaging and/or goods on Packing List and have it signed by the shipper's agent prior to accepting the shipment. Submit damage claim to Cosa immediately.

NOTE: Damage claims not received by COSA within 3 days of receipt of shipment will not be accepted.

Important notice!

This high quality electronic analyzer utilizes batteries that discharge even when the analyzer is not in use. Therefore it is very important to charge the batteries every 4 – 6 weeks, ***even if the analyzer is not in use***. When it is fully charged, the analyzer should be switched on and allowed to zero itself before being switched off again. (see chap. 11.8)



Failing to properly charge the batteries will void your warranty!

Save the original box and the packing material for use if the analyzer must be shipped in the future.

This manual is intended solely as a guide to the use of the product.

Cosa shall not be liable for any loss or damage whatsoever arising from content errors or misinterpretation of information's from this manual or any mis-use resulting from the use of this manual.

2 Introduction

2.1 The COSA 707

The COSA 707 flue gas analyzer is used for:

- Precise flue gas measurement of almost any type of combustion
- Short control of measurements stacks, kilns, furnaces and many other sites.

It can also be used (when optionals are activated or external equipment is used) for a number of measurement tasks, such as:

- Flow velocity measurement of flue gas
- Differential measurement of pressure and temperature
- Combustibles detection with external HC sensor

You will find a list of all optionals for this analyzer on our web page or you can contact COSA or our local representative.

The COSA 707 Analyzer is available in different versions. This manual will describe all versions indicating optionals and features not always available on both versions.

2.2 The company

For over 25 years, COSA Instrument has focused on bringing state-of-the-art measurement solutions to the North American market from leading instrument companies around the globe. The pioneering approach of supporting its partners with full application engineering and service has allowed COSA Instrument to successfully introduce new technologies to solve customer measurement needs. Now combined with the advanced sensor technologies of Xentaur Corporation, the new entity COSA Xentaur is supplying innovative measurement solutions to customers worldwide.

2.3 Important general information (EN 50379) and VDI 4206

This analyzer is not designed to be used for continuous measurements.

Before using the analyzer verify the condition of the various parts of the analyzer, such as the probe, the ambient air conditions, the condensate separator, star filter and the connectors for damage and/or blockages.

When starting up the analyzer it will take between 1 – 3 minutes to set to zero depending on the condition of the sensors and of ambient.

The minimum zeroing time of the analyzer to achieve correct measurement values can be expected by 1.5 minutes!

Caution: Exposure to acids; aggressive gases such as sulphur; vapours such as thinners, gasoline, alcohol and paint, etc. can damage, reduce the life of, or destroy the sensors.

The life of the sensors depends on how they are used, maintained and treated. Typical average life expectations are: O₂ - 2 years; CO - 2 - 3 years; NO - 3 years, NO₂ and SO₂ approx. 2 – 3 years.

The use of the analyzer for regulatory purposes is subject to special regulations (for example a periodical examination of the analyzer). Please obtain the appropriate regulations from your local responsible authority.

2.4 Important information about the users/operation manual

The users/operation manual is an important part of this delivery. It will explain how to use this analyzer properly and sets forth safety and environmentally friendly procedures.

It is the responsibility of all users to read and familiarize themselves with this manual, paying particular attention to the safety instructions.

The most important safety details are listed in chapter 3 (Safety Information). Additional safety details in other chapters are clearly marked with an **attention** sign.



3 Safety Information

The following safety procedures must to be followed at all times. They are a significant and essential part of this manual. Failure to follow safety procedures can result in the loss of your warranty claims.

3.1 Safety regulations

1. The COSA 707 analyzer may only be used as indicated in this manual.
2. Our analyzers are checked according to the following regulations: **VDE 0411 (EN61010)** and **DIN VDE 0701** before they leave the factory.
3. Technical products are designed and manufactured according to **DIN 31000/ VDE 1000** and **UVV = VBG 4** of the professional guilds for fine mechanics and electrical engineering.
4. The analyzer complies to the essential requirements of the legal regulations of the member states of the electro-magnetic compatibility (**89/336/EWG**) and to the low-voltage regulations (**3/23/EWG**).



3.2 Specific safety regulations

1. Use only the battery charger supplied with the analyzer for this instrument
2. No part of the analyzer, including the metal probe tube and all other metal parts & accessories are to be used as electric conductors.
3. The analyzer is not to be used in or under water.
4. The analyzer is not to be placed near or directly exposed to open fire or heat.
5. The specified probe temperature range is not to be exceeded, as the probe, temperature sensory mechanism and sensor could be damaged or destroyed.
6. The analyzer shall void dropping.

7. Caution: Moisture, being pumped out of the condensates trap can be slightly acidic.
In case of skin contact IMMEDIATELY: clean affected parts of the body.
Avoid getting liquid in eyes.
Please carefully clean all parts that come into contact with the condensates.



8. After measurement, vent the analyzer with ambient air and allow the probe to cool. A hot probe could cause burns or ignite flammable material.



9. The fumes from certain materials (for. example, cleaners, petrol, spirit, varnish) may damage the sensors of the analyzer. Do not store or use these or other similar fluids near the analyzer.



4 RETURNED GOODS

Packing regulation of 12.07.1991

If your local waste facility does not except packing materials for disposal, you may return it to our local sales representative. Packing materials returned to COSA must be returned prepaid.

5 MEASUREMENT PRINCIPAL

The analyzer draws a sample of the flue gases from the duct using a built-in gas pump through the probe is cleaned and dried using condensate separator with built-in filter and analyzes the extracted gas with electrochemical sensors.

Draft and temperature are measured at the tip of the sampling probe.

5.1 Gas flow diagram

Gas flow diagram with CO purging pump

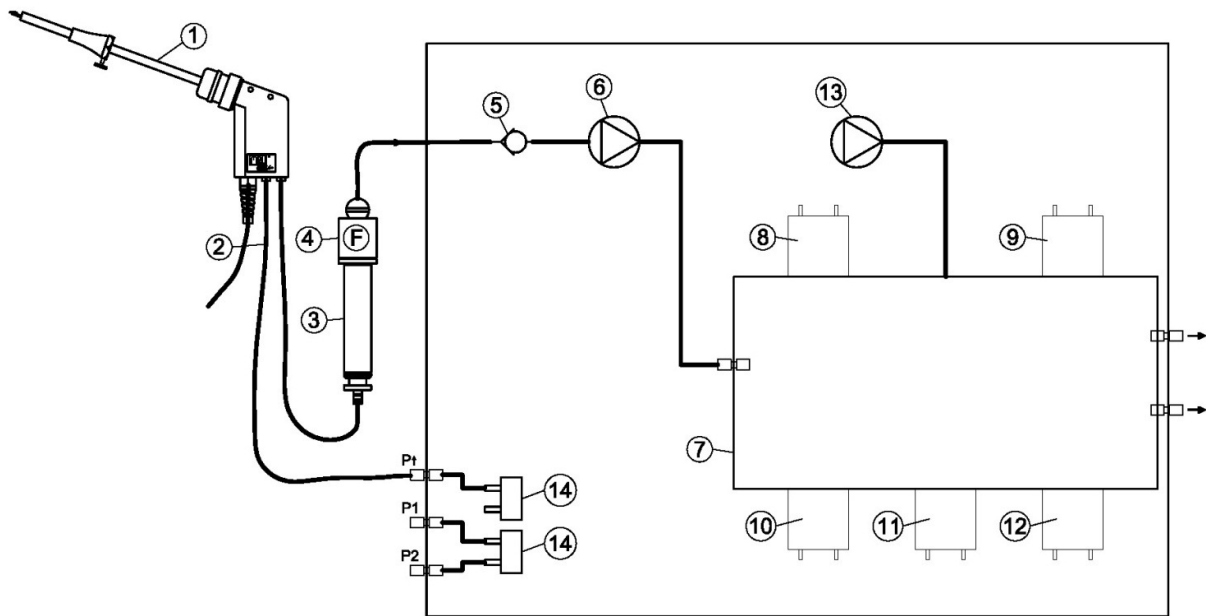

Position	Description
1	Sampling probe
2	Triple hose
3	Condensate separator
4	Star filter
5	Non return valve
6	Gas pump
7	Sensor chamber
8	O ₂ -Sensor
9	2. sensor
10	3. sensor
11	4. sensor
12	5. sensor
13	CO Purge pump
14	Pressure sensor *

* optional

5.2 Electrochemical measured principle

The oxygen content of the sample gas is measured with a 2 electrode electrochemical sensor.

Toxic gases like carbon monoxide (CO), nitrogen oxide (NO), nitrogen dioxide (NO₂), sulphur dioxide (SO₂), and hydrogen sulphide (H₂S) are measured with 3 electrode sensors.

The electrochemical sensors are based on gas diffusion technology.

The advantage of this technology is that the signal generated is direct proportionally and linear to the volume concentration (% or ppm) of the analysis gas components.

The 3 electrodes are: S (sensing electrode), C (counter electrode) and R (reference electrode).

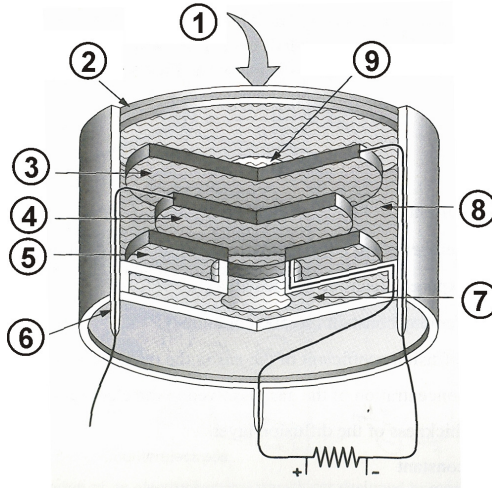

Pos.	
1	Sample gas
2	Particle filter
3	Sensing Electrode
4	Reference Electrode
5	Counter Electrode
6	Connection pin
7	Electrolyte reservoir
8	Electrolyte
9	Capillary diffusion barrier

When the gas being measured contacts the sensing electrode, it reacts on the electrode surface either through oxidation (for example CO, SO₂, NO) or reduction (like NO₂, and Cl₂).

Example: CO sensor:

CO reacts at the sensing electrode as follows:



and at the counter electrode, oxygen from air will be re-oxidized to water:

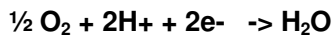

The sensor supplies a constant current signal (µA-range) that is monitored and analyzed. The current intensity is dependant upon the volume concentration of the sample gas, while other parameters like temperature and cross sensitivity are calculated by the analyzer.

6 ANALYZER DESCRIPTION

6.1 Analyzer front



1	Display
2	Condensate separator
3	Key pad

6.2 Analyzer Connectors - bottom side

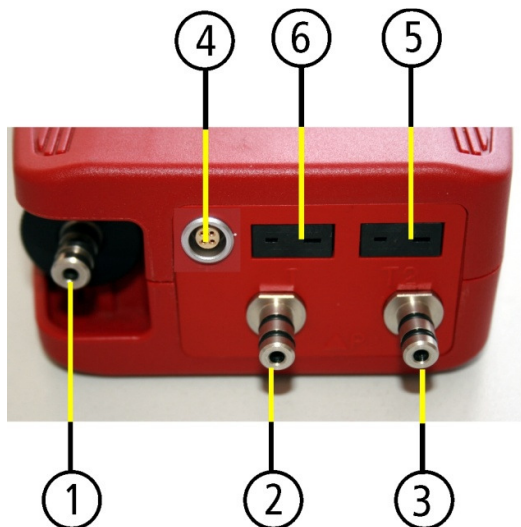

1	Sampling probe connection Condensate separator
2	Pressure connection 1 (Draft)
3	Pressure connection 2 (Differential pressure)
4	Connector AUX (optional)
5	Temperature connection 1 / T-Ambient air (combustion air)
6	Temperature connection 2 / T-gas

Note:

If during zeroing T air (5) is disconnected, then value of T gas at the end of zeroing will be used. In this case, the measuring value will be displayed green coloured.

If T air (5) will be connected during the measurement, then true T air measurement will occur and the display color changes from green to black.

6.3 Analyzer Connectors - top



1	Cover
2	IR-interface
3	SD-card reader (only by using a COSA-SD-CARD we can assure the compatibility of all analyzer functions)
4	USB-port and charging port

6.4 Analyzer Back



1	Fixing magnets
2	Gas outlet
3	Handle strip
4	Analyzer feet



Important!

During measurement the gas outlet may not be covered

6.5 Condensate separator

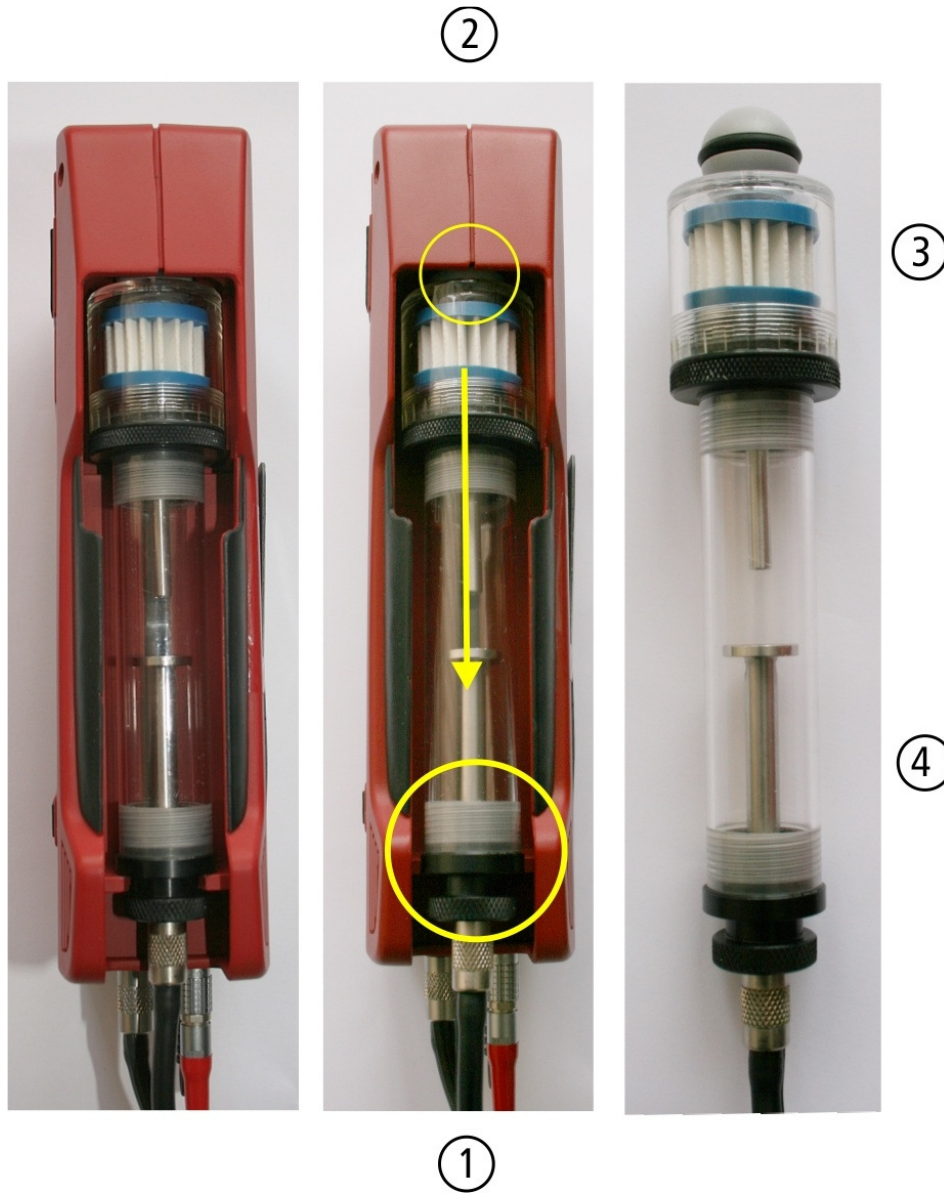

Remove the condensate separator by pulling it towards you (1) out of the groove of the COSA 707 housing, then pull it downwards (2).

The condensate show glass is screwed into the plug. The complete condensate separator can easily be taken apart for cleaning or for exchanging the star filter. (Condensate separator details are included in the service manual)

After cleaning a leaknes check (see chap. 14.4) must be done!

7 ACCESSORIES

7.1 Gas sampling probes

The COSA 707 is available with different probes, both with fixed and exchangeable probe tubes. A complete list of available probes can be found in the current price list of this analyzer.

Below are two different probe types:

Probe ST

With 180 mm probe pipe (fixed) and 1,5 m sampling line

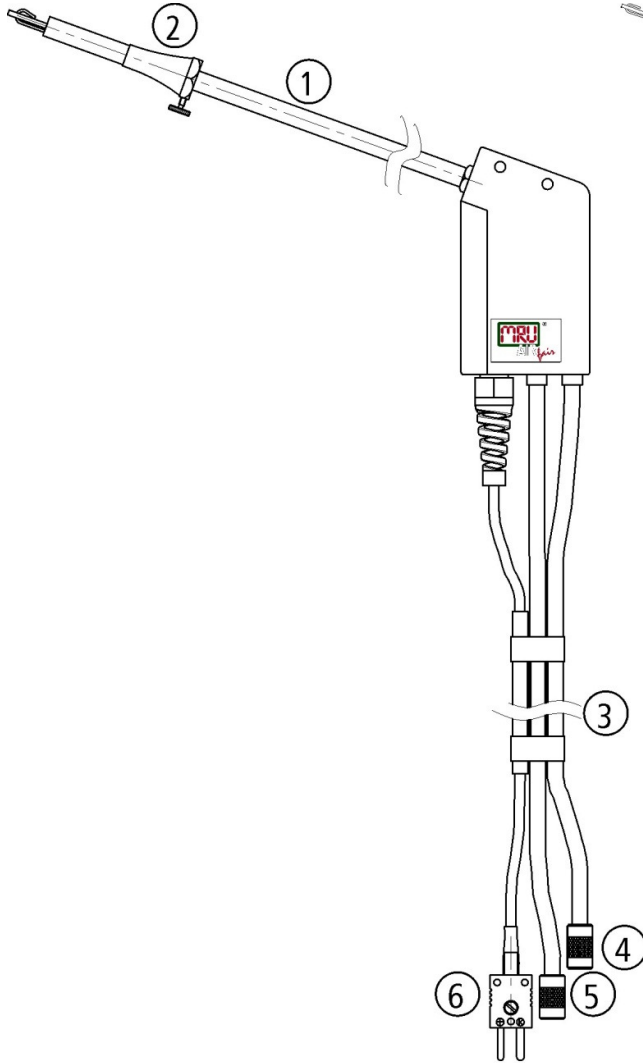

Probe SF

With 300 mm exchangeable probe pipe and 2,7 m sampling line

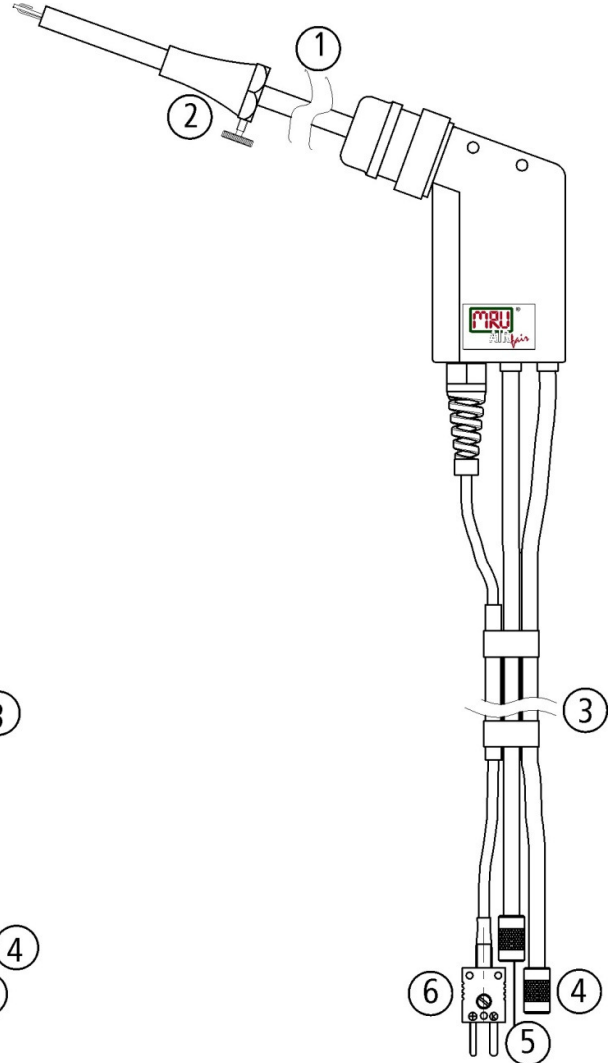

1	Probe tube
2	Probe cone (high grade steel)
3	Triple hose (NBR or Viton)
4	Connector for sample gas measurement
5	Connector for draft measurement
6	Connector for temperature measurement

8 OPERATING THE ANALYZER

8.1 The Display



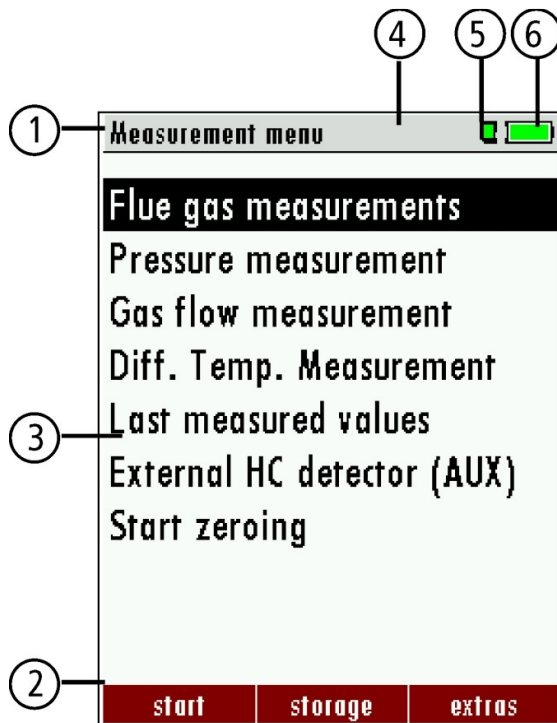

All information required to operate the analyzer is displayed as shown below.



1	Menu bar
2	Function key bar
3	Display panel <ul style="list-style-type: none"> - Menu - Measurement value - ...
4	Zeroing active
5	SD-Card in the slot <ul style="list-style-type: none"> - Indication green Read- and write access - Indication yellow only Read access (SD-Card write protected)
6	Battery charge condition

8.2 The Keypad

Description and function of the keys:

ON/OFF 	Press to start the analyzer without delay. The power off function will be delayed to protect the sensors. If there is not enough ambient air the analyzer will recommend the purging of the sensors.
Function Keys 	Activates the functions seen on the display (2 function key bar)
Menu Key 	Will show all available functions in the window that is currently in use – also those which have an individual key on the key pad like the printer and the three function keys.
ESC Key 	Abort or return to the menu above
Arrow Keys	Jump in between lines, change values
OK Key 	Confirmation key, select a marked menu point
Printer Key	Activates the printer function in the measurement and

	service window.
---	-----------------

8.3 Menu configuration

The COSA 707 organizes all available actions in three main menus:

- Menu Measurement → all tasks for the measurement programs of the analyzer. Here you can select all installed and available measurement programs.
- Menu Memory → all tasks for the management of the data memory available.
- Menu Extras → all the other available tasks – for management and customizing your analyzer.

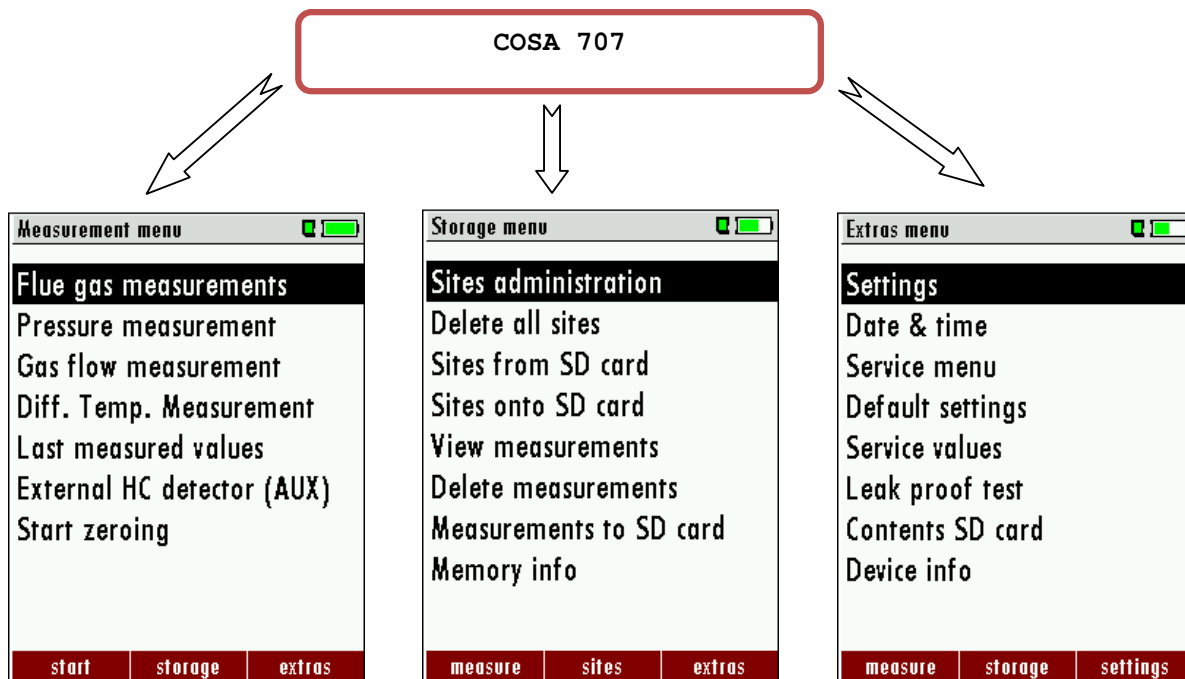

The topic „Flue gas measurements“ is a standard feature in every analyzer and is explained in chapter 12. Other menu points are optional and will be explained either in this manual or in an additional manual or flyer.

Please read chapter 13 for details.

Please read chapter 14 for details.

You can jump in between the 3 main menus with the 3 function keys (according to the displayed name on the screen).

9 FIRST USE OF THE INSTRUMENT

After the analyzer has been inspected and is ready for start up it can be switched on and personalized settings can be entered. These settings can be changed at any time.

9.1 Analyzer ready for operation

- Unpack the analyzer, read the complete manual
- The analyzer was shipped completely assembled, in working condition and ready for operation. It is recommended that the analyzer is thoroughly inspected for completeness and damage.
- Recommendation: charge the batteries for 8 hours prior to use.
- Check/Change date and time

9.2 Analyzer settings

The “Settings” menu allows to configure some instrument specific parameters.

In the main menu “EXTRAS“ = “F3 key” - scroll down to “Settings“ then press the “OK“ key, By selecting a line the parameter value can be changed by the arrow keys.

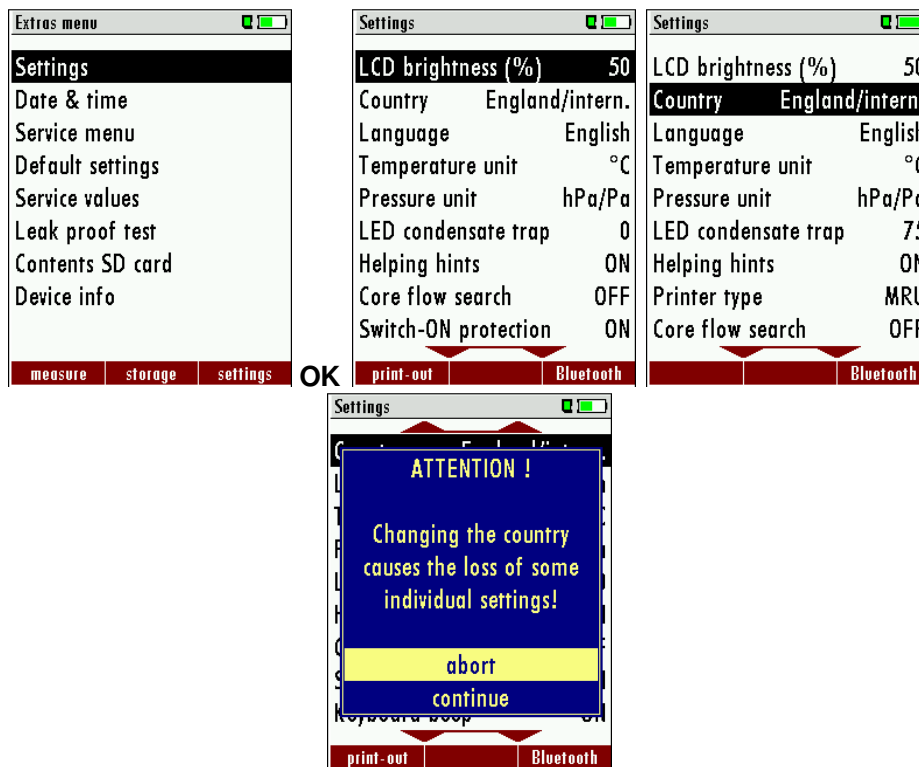

LCD brightness	5 – 100 %	Display-brightness, depending on temperature and also on the personal judgement of the user, at 20 °C a value of ca. 50% is normal
Language	DE/GB/FR/ITCZ/RO/TR/ES/	Select device languages
Country	DE/USA/GB/IT/AT/RO/ES/ plus others	Enables some country specific parameters like fuel types, calculated values etc.
Temperature Unit	°C, °F	Change the unit for temperature in all screens
Pressure Unit	Pa, hPa/Pa, hPa, kPa/Pa, kPa, mbar, mmH2O, cmH2O, inH2O, mmHg,	Change the unit for pressure in all screens. The meaning of hPa/Pa and kPa/Pa is that the instrument performs a dynamic change of unit depending on the absolute value

	inHg, PSI,	of pressure.
LED condensate trap	0 ... 150	Change the brightness of the condensate separator LED
Helping hints	ON / OFF	Helpful hints activated or deactivated (explanation below)
Core flow search	ON / OFF	Core flow search before start of each flue gas measurement: activated or deactivated
Switch-ON protection	ON / OFF	If activated and if ON key is pressed (possibly inadvertently), then the message „3 seconds OK key press “ displays
Keyboard beeper	ON / OFF	Keyboard beeper activated or deactivated

Explanation for “Helping hints”:

Some helpful hints which are very useful for an inexperienced user but are not needed by experienced users, can be activated or deactivated. The following hints will be affected:

- “Zeroing finished, Sensors are ready. Analyzer ready for measurement.”
- “Reminder! Charge batteries at regular intervals!”
- “Measurement stopped/started.”

9.2.1 Switch-ON protection

If activated and if ON key is pressed then the message: „Switch-ON protection is activated – Press OK for 3 seconds“ is displayed. Now press the OK button on the centre of the keypad for three seconds.

9.2.2 Setting printer type

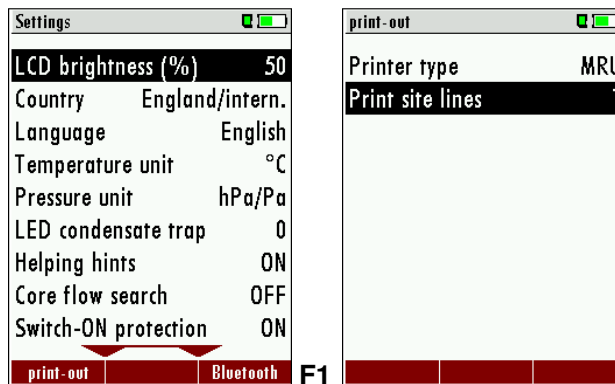

Printer type	COSA / HP	Select printertype
--------------	-----------	--------------------

9.2.3 Bluetooth settings

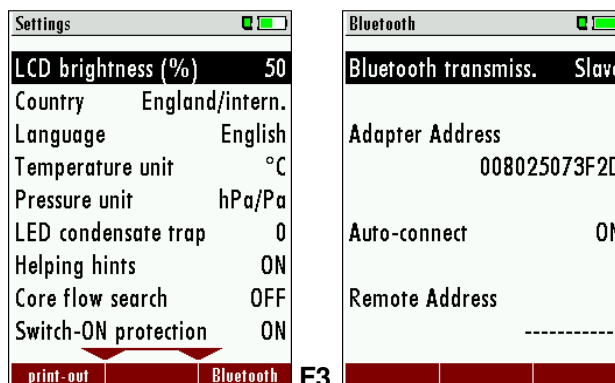

If RemoteData, OnlineView or MRUConnect (PDA) with Bluetooth is used, the SLAVE move mode must be selected. The auto connect mode must be switched OUT.

(Further description in the manual part of 2 OPTIONS)

9.3 Setting time and date

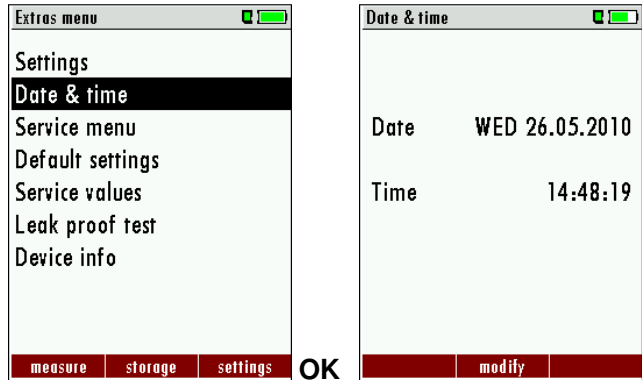

F2	Edit
▲, ▼	Change the marked number
◀▶	Move the cursor to the next position
ESC	Return to <i>Extra-Menu</i>

9.4 Configuration of measurement program

(Flue gas measurements) Select one of the 4 configurable measurement programs.

For each of the programs the following parameters can be configured:

- CO ppm limit: adjustable value for the CO sensor protection. If the CO value in the flue gas is higher than the adjusted value in the analyzer, the purge pump will be activated and the sensor will be protected against high CO concentrations. (Optional)
- Selectable fuel types: choose and select from the available fuel type list
- Measurement windows: configuration of what and where will be displayed in the 3 measurement value windows.
- Zoom – window: select what will be displayed in the zoom - window
- Program name

The following programs have a pre configured:

- “Test Program” indented for use at instrument maintenance and calibration

9.4.1 Setting the CO ppm limit values

The CO ppm limit can be adjusted in the window „Measuring program selection“.

Select one of the available programs (arrow up/down) then press the F1 key.

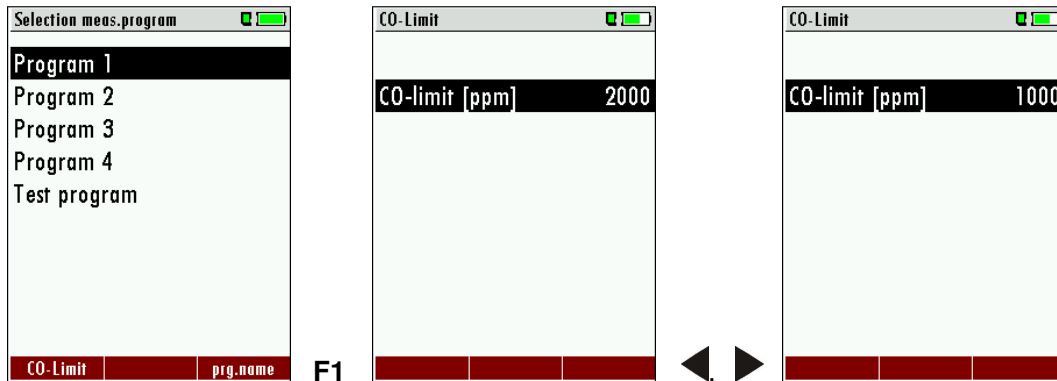

▲▼	Select one available program
F1	Open the CO ppm limit window
◀▶	The CO-ppm limit value can be adjusted in 100 ppm steps between 300 ppm and 4.000 ppm / 10.000 ppm
OK oder ESC	Return to the measurement window

9.4.2 Fuel type selection and O₂ reference

Each time you start a measurement program you can select a fuel type from the fuel type short list. This short list is linked to the measurement program and can be configured as a sub set of fuel types from the total fuel type list.

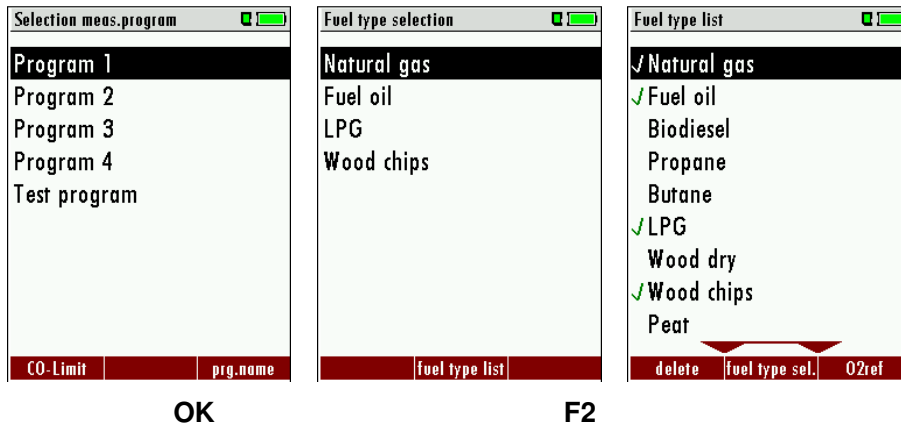

▲▼	Select a program
OK	Show a pre selected fuel type
F2	Show the list of all fuel types

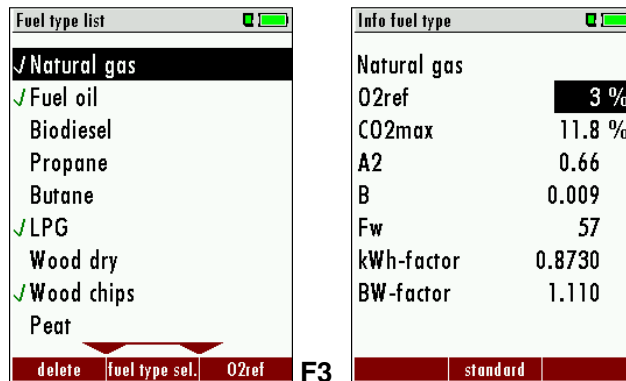

F1	Add / remove a fuel type
F2	Exit the fuel type list
F3	Input O ₂ -ref with the keys ◀▶

First select a program then press OK – then press the F2 key in the window “Fuel type selection”. All available fuel types are displayed: they can be added to or removed from the short list by using the F1 key. Added fuel types have a check mark in front of the fuel type.

To each fuel type the parameters are displayed by selecting F3 “O₂Ref”. All parameters are displayed read-only except the O₂” reference value that can be changed.

9.4.3 User definable fuel types

Here, four fuels are adjusted individually. The name as well as the parameters are adjustable. As the other fuel types, they can be pre-selected or left out.

Note:

The last 4 fuel types at the list are the user fuel types.
The user fuel types are coloured green.

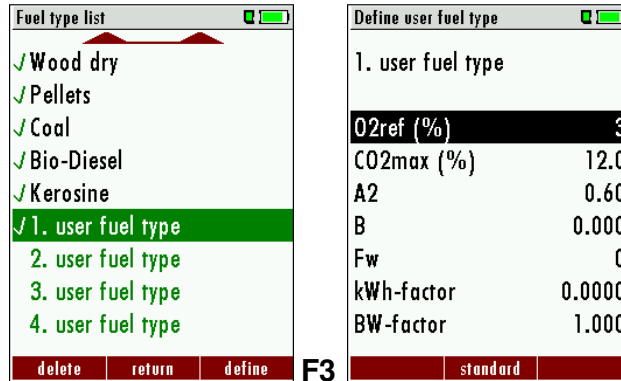

F1	Add or remove selected fuel to the pre-selected fuel types
F2	Back to the window “Fuel type selection”
F3	Modify fuel type parameters

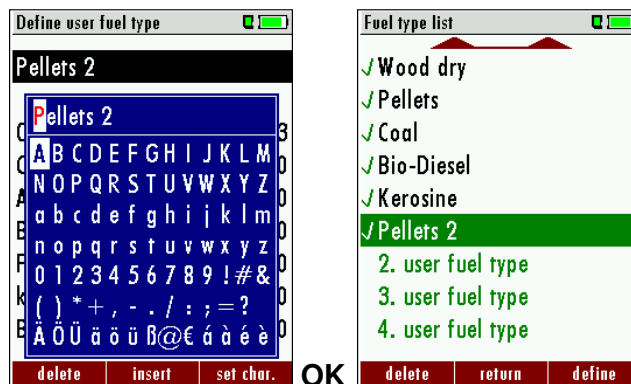
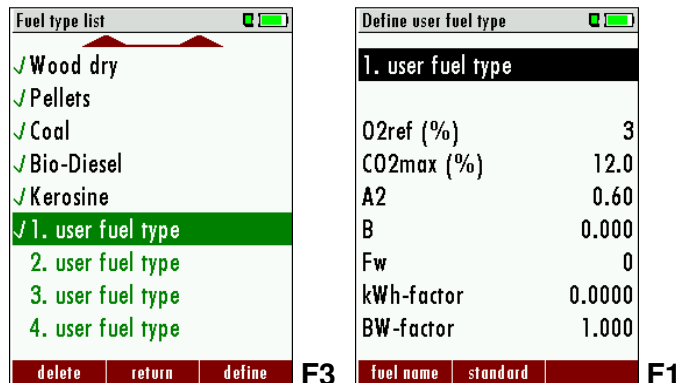

F3	Modify fuel type parameters
F2	Modify fuel type name Text input see chapter 16.1

OK	Save the new fuel type name
-----------	-----------------------------

9.4.4 Configuration of the measurement window (display content)

Start the measuring program – once you are inside the measuring window press the  key.

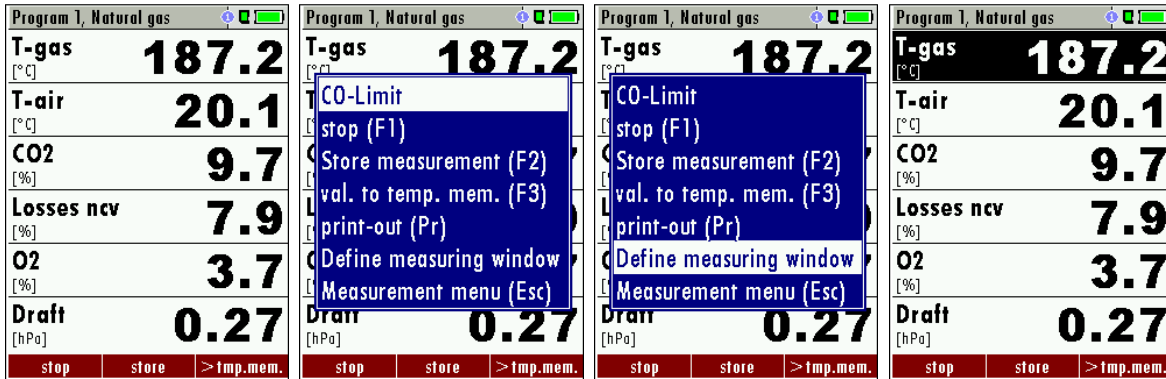

Now you select “define measuring window” and press the OK key. The top value will now be marked black – this black bar can be moved up and down. Move it to the position that you would like to change or to the position where you want to add a measuring value. Once you have reached the position you can use the arrow left and right keys to change the measuring value.



When all your changes have been made, you press again the **menu** key. Now you select “Save measuring window”. All your changes will be saved and all saved values will be printed when using the printer function.

Start the measuring program – once you are inside the measuring window press the **menu** key.

9.4.5 Configuration of the zoom function

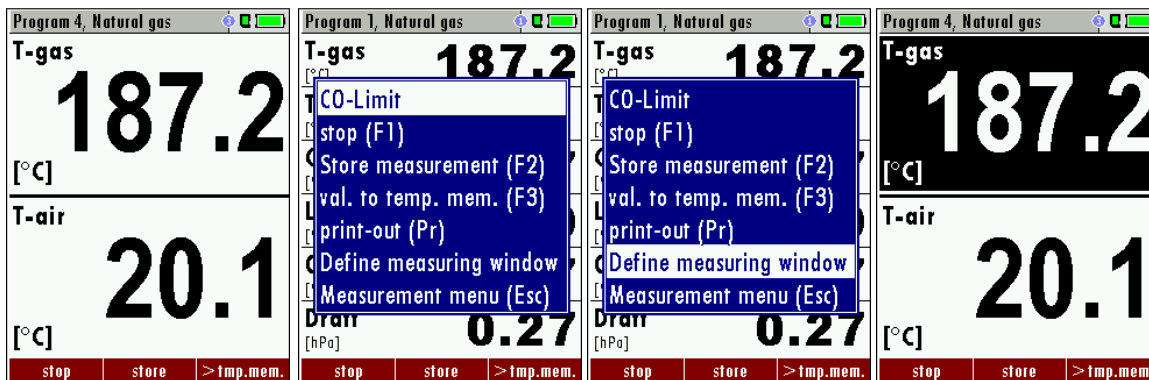
For each measurement program you have 3 zoom windows with two selectable values for each window.



	Change Zoom window 1..3
	Change measuring values
	Save measuring window and save configuration

9.4.6 Change measurement program names

In the “Fuel type selection” window you can edit the marked program name with the F3 key and then change the program name.

9.4.7 Select core flow search

You can choose if you want a core flow search before every measurement or not. This function is only possible in the programs 1 -4. Enabling the core flow search is a global instrument setting valid for all programs and therefore described in chapter 9.2

10 Maintenance

The COSA 707 needs to the long value preservation only one very low maintenance need:

- now and then: Cleaning of the probe and the probe tube
- after every measurement: remove gas sampling tube from the COSA 707, so that the hose can dry
- after longer disuse load battery first and afterwards approx. all 4 weeks

11 PREPARATION FOR EACH MEASUREMENT

11.1 Power supply

The analyzer can be used with:

1. with the internal battery (provided)
2. with the battery charger (provided)

External equipment may only be connected while the analyzer is switched off!

11.2 Auto Off

The instrument is automatically switched off after 60 minutes. During a measurement or a battery charging cycle the auto off is deactivated.

11.3 Measurement with battery charger/battery charging

When ever you connect the analyzer with external battery charger (90..260 V / 50/ 60Hz) the battery will be charged.

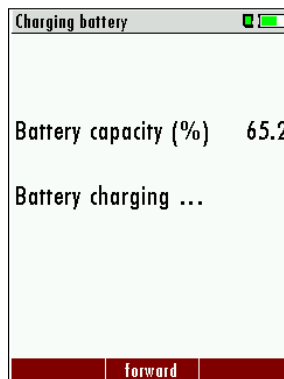

Once the battery is fully charged the analyzer will switch to trickle charge mode. At the moment, if the battery is fully charged and the trickle charge mode begins, an acoustic feedback will be played..



11.4 Measurement with battery (Battery monitoring)

The battery symbol in the top right corner displays the current battery charge condition.

Approximately 15 minutes (depending on the analyzer configuration) before the battery is drained, the battery symbol will start to blink red (about once per second).

When the battery is almost drained and the analyzer is not connected to the battery charger within one minute, then the analyzer will switch off automatically to prevent deep discharge of the battery.



11.5 Operation temperature

If the analyzer has been stored at low temperatures, it will require some time to equilibrate to the ambient temperature before being switched on. If it does not equilibrate, condensation will occur inside the analyzer!

If the temperature is out of its operation range (see chap. 15), you will see the following messages on the display.

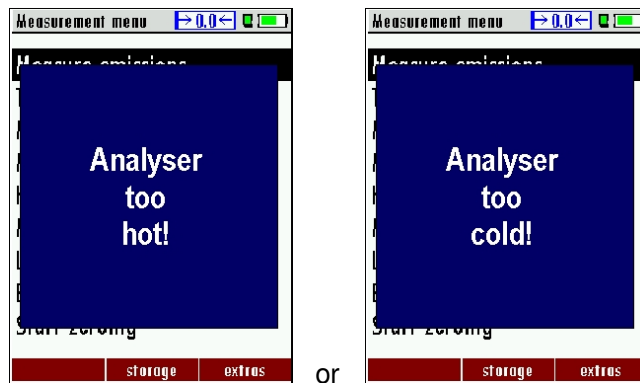

Once one of these messages appears you will not be able to use the analyzer, it will give an acoustic signal until it has reached the specified operation temperature between +5 °C and +45 °C.

11.6 Condensate separator

The condensate separator must be checked before and after each measurement!

Please check if the condensate separator must be **emptied** and if the star filter is still **white**.

White = good for measurement dark = replace



11.7 Connectors and leak tightness

- Check all push on connectors for proper fit.
- Check all hoses, hose connectors and the condensate separator.
- Start separate instrument tightness test (see chap. 14.4)

11.8 Power ON and zeroing

Press the ON key. The analyzer will start zeroing without any further action from the user. The probe shall **NOT** be installed in the stack during zeroing!

While the analyzer is zeroing you will see a blinking $\Rightarrow 0.0 \Leftarrow$ symbol in the task bar indicating the progress of zeroing.

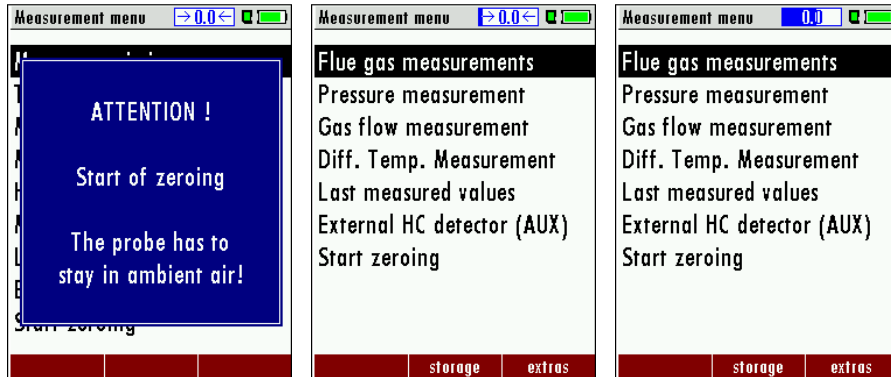

Once the zeroing cycle is finished the analyzer is ready for measurement.

If any defective sensors will be detected during the zeroing cycle you will get an error message on the display.

Repeating the zeroing

The zeroing can be repeated at any time as long as the probe is not inside the stack. In the main menu you select “Zeroing”, and after the displayed message press the OK key.

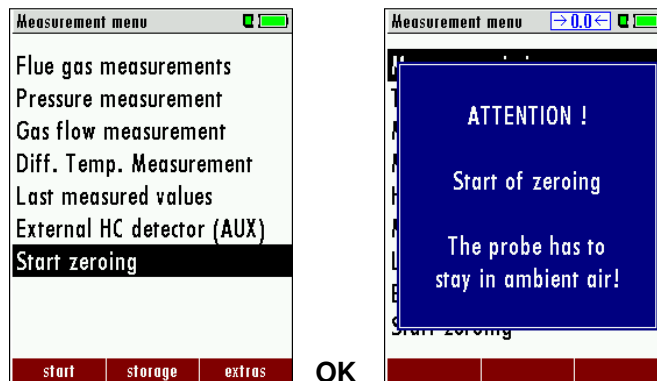

▲, ▼	Zeroing
OK	Start zeroing

12 HOW TO TAKE A MEASUREMENT

Every COSA 707 is capable of making a complete flue gas measurement. How to perform this is described below.

The description of other optional available measurement programs can be read in the appendix or in additional flyers.

12.1 Selection of the measurement program

In the measurement menu select "Flue gas measurements" then select one of the available programs.

If you press the F1 key "Start" in the measurement menu, you will be directed directly into the measurement screen, using the parameters (program and fuel type) that have been selected last time the analyzer was used.

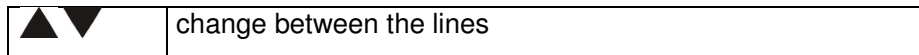
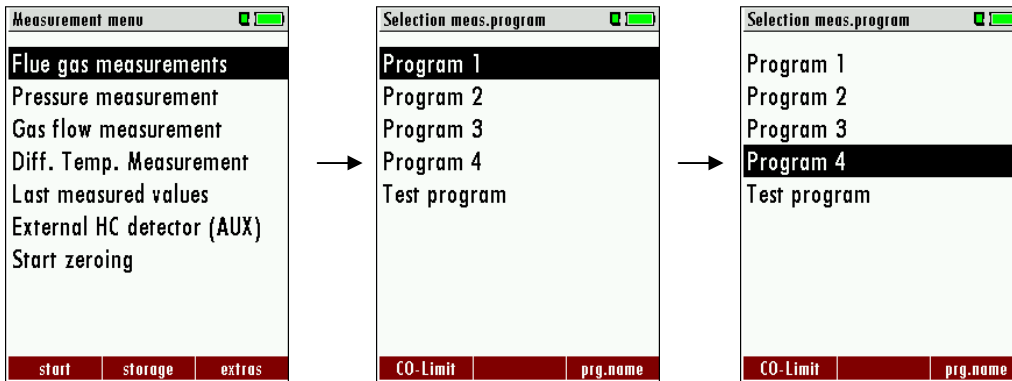

12.2 Core flow search

Before using the core flow search it must be switched-ON:

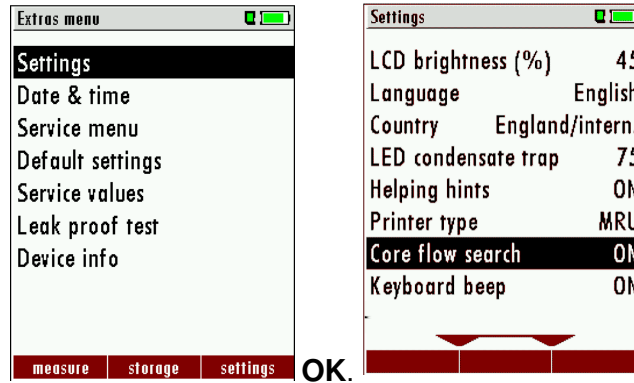

OK.

The core flow search will help you to find the optimal measurement point in the stack. The core flow can be identified by the maximum flue gas temperature.

In high reaction time the analyzer displays the trend of the flue gas temperature. Insert the probe pipe slowly into the stack and position your probe tube when you have reached the maximum flue gas temperature that is displayed.

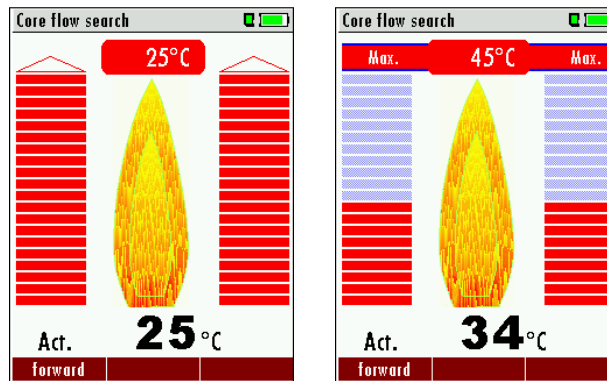

Temperature rising

Approaching the maximal flue gas tem-

perature

Positioning the probe in the core flow:

Insert the probe pipe slowly into the stack and position your probe pipe when you have reached the maximum flue gas temperature that is displayed (see temperature maximum value on the display – in this case 69°C).

Maximum temperature has been reached when the arrows (left picture) disappear, max. (right picture) appears in place of the arrow, and the beeper signal stops. Moving away from the max. temperature will result in the bars moving away from the max. temperature (1 bar is equivalent to 1°C). Once the right core flow has been achieved, the probe is fixed with the probe cone screw.

12.3 Measured Value Display

After the core flow search you will see the measurement values on the display.

Measurement values can be organized on three pages, each page displaying 6 measurement values.

The order of the display is operator settable. (see chap. 9.4.4).

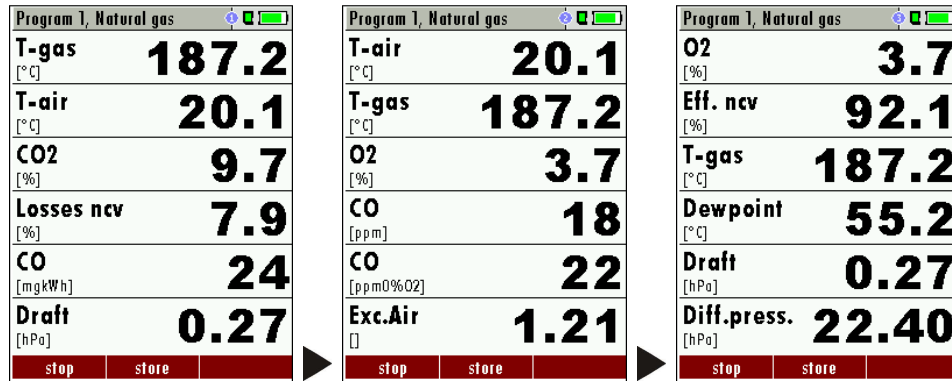

There are direct measured values available such as Oxygen and Temperature as well as calculated values such as dew point, efficiency and CO₂. You will also find the same measurement value in different calculated values such as CO in ppm or CO in mg/kWh.

Values that cannot be displayed are indicated with dashes. Possible reasons for value not being displayed are:

- Electro chemical sensor was detected as defective during zeroing.
- External temperature sensors are not connected.

The measurement value T-Gas is usually read at the connector “T-Gas/AUX” (depending on configuration) or if not available from the connector “T1”. (see chapter 6)

There are three measurement windows available, with the arrow keys left and right moving between them.

Zoom function, each with two values, is activated by moving the arrow keys up and down. Moving arrow keys left and right pages between the two zoom windows.

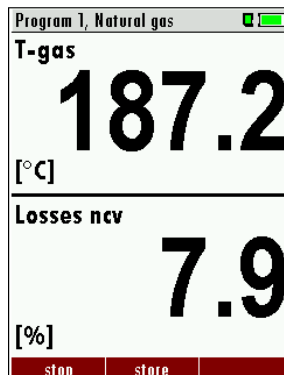

12.4 Non-continous draft measurement

The COSA 707 provides for a non-continous draft measurement. The draft measurement is disabled when a maximum time after zeroing has elapsed or a significant change in temperature has been detected by the instrument. The maximum time is configured to 10 minutes.

If the draft measurement is disabled it is displayed with “--.-“. The draft measurement can be enabled again by zeroing the draft: F2 key “zero draft”.

To indicate that the draft measurement is not continuously available it is displayed in color red.

Program 1, Natural gas		Program 1, Natural gas	
T-gas [°F]	72.0	T-gas [°F]	73.0
T-air [°F]	74.0	T-air [°F]	72.5
CO2 [%]	--.-	CO2 [%]	--.-
Losses ncv [%]	--.-	Losses ncv [%]	--.-
O2 [%]	20.9	O2 [%]	20.9
Draft [Pa]	36.4	Draft [Pa]	--.-
stop store hold draft		stop store zero draft	

The user can freeze the draft data by means of the F3 key “hold draft”. The frozen data is displayed in green. To unfreeze the measurement one has to exit the menu and enter again.

Program 1, Natural gas	
T-gas [°F]	70.5
T-air [°F]	72.0
CO2 [%]	--.-
Losses ncv [%]	--.-
O2 [%]	20.9
Draft [Pa]	39.6
stop store > clipboard	

All other measurements are processed continuously independent of the draft measurement status.

12.5 CO purging (optional)(not possible with CO2 IR sensor)

When the CO ppm limit is reached the analyzer will start the CO purging pump to protect the CO sensor from getting saturated with CO. Other values will not be affected while the CO sensor is being purged.

While the CO sensor is being purged the CO value is not displayed and dashes will appear on the display. The dashes will remain red as long as the CO value is higher than the CO ppm limit, and they will turn black once a level below the selected ppm value has been reached.

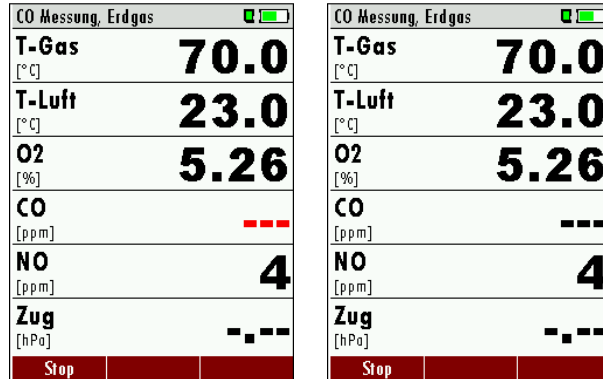

The purging does not stop automatically: it must be turned off by the user.

Press the “Folder”  key and select “purge pump off” to cancel the CO purging function.

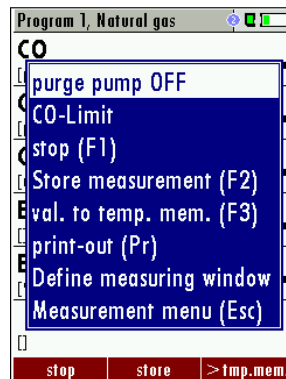

The actual CO value will then be displayed again.

12.6 CO/H2 and BigCO (optional)

If that exceeds CO the CO threshold, then to BigCO, the measured value is red indicated - also the calculated values - is switched.

The CO value exceeds 10.000 ppm to % is in such a way switched (example 1.00%).

If the CO value sinks below the CO threshold, then the red CO value becomes again black

Starting from this moment the purge pump can be switched off over the menu key

12.7 Test program

This test program is made for testing facilities that will test these analyzers with test gases and don't need to make any modifications.

In this program you will only see measured values and no calculated values at all.

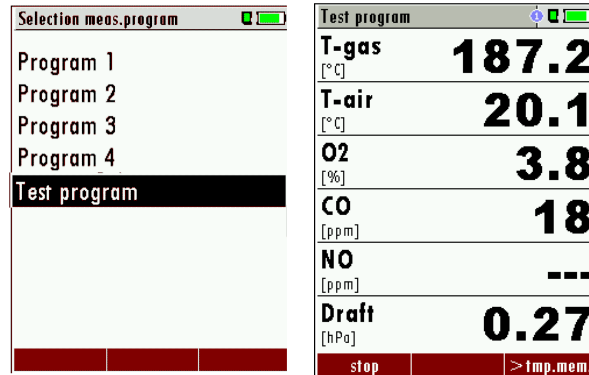

12.8 CO ambient

In some countries the measuring program CO environment is demanded. The objective of this measuring program is the proof of CO concentration in the environment of the measuring point. In the case of the country setting in the main menu the menu option is indicated „CO ambient“.

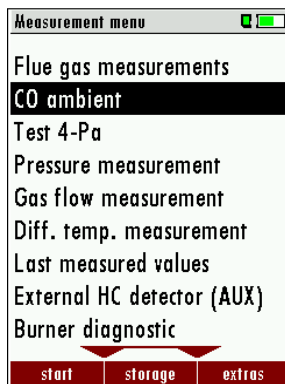

Before that CO ambient measurement a zeroing at fresh air (outside of the environment of the measuring point) must be taken.

Start thereafter the function „CO ambient “at fresh air with the **OK** key.

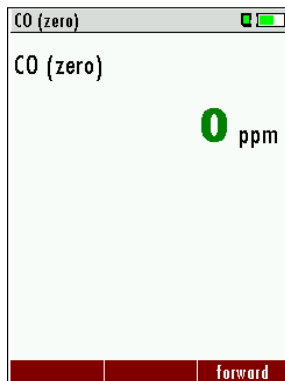

F3

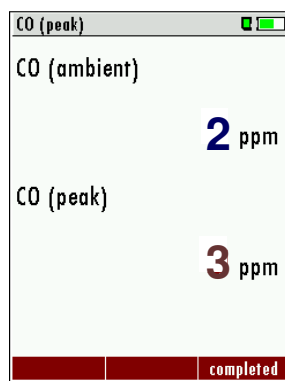

F3

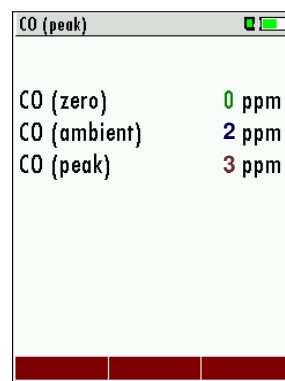

The current CO value (zeroing) as a check is indicated. (This value must be approx. 0 ppm!) The CO ambient measurement starts through pressing the key **F3** at the measuring point. The current CO (ambient) and CO (peak) values will be indicated. The measuring result will be indicated by pressing the **F3** key. This can be printed out by the **printer-key**.

With the **ESC** key one reaches back in the main menu.

12.9 Temporary buffer

The COSA 707 gives the possibility to set the momentary values into a temporary buffer during effecting and continuing the measurement. Later on, the values can be brought back from the temporary buffer to the measuring window in order to print them out or / and to save them

12.9.1 Set values into temporary buffer

During an actual measurement you can set the actual values into the temporary buffer
Operation:

- the function „val. to temp. mem.“ of the menu (accessible about the menu button)

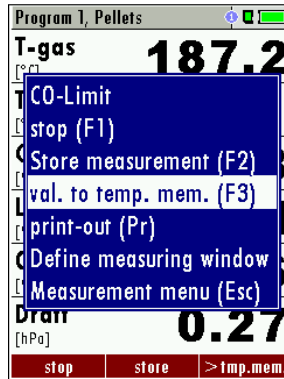

- or, provided that offered, the function key F3 with the text **>tmp.mem.**

12.9.2 To bring values back from the temporary buffer

With stopped measurement you are able to change the indicated values with the buffer content.
Operation:

- the function „v./tmp.mem.“ of the menu (accessible about the menu button), or
- the function key F3 with the text **v./tmp.mem.**

Now you can change the current values and the values of the temporary buffer with the key F3. This change of the actual values with the values of the temporary buffer memory can be executed several times one after the other

Now it is possible to print and save as usual one of both measurements.

12.10 Storage the measuring results

If in the function key bar "store" is indicated, you can store with the accompanying function key F2 or F3 the measurement in the data memory. The function of the data memory is explained in chapter 13.

12.11 Printing the measurement results

While in the measurement window pressing the printer key will send the information to the IR printer.

The speed printer (IR desktop printer) Art. No. 62693 must be aligned in addition as follows:

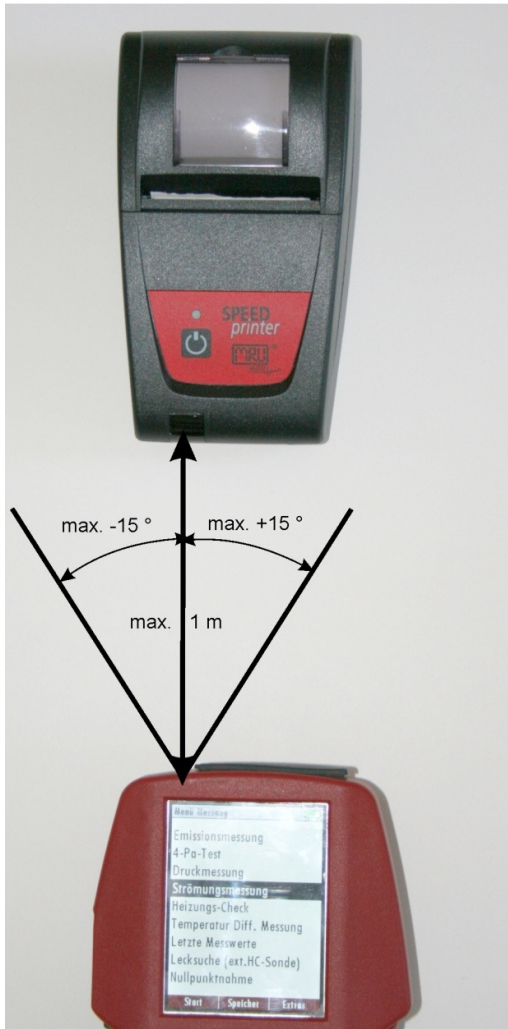

All values that can be seen in the measurement window on all three pages will be printed, double measurement values will only be printed once.

Further technical specifications as well as battery and paper rolls changes please see separate printer manual.

12.12 End of measurement

A current emission measurement can be stopped at any time with the F1 key. The display will change its colour and the measurement will be frozen. At the time you stop the measurement all measured values are still available and can be viewed at a later time (see chap. 12.13).

Return to the measurement menu by pressing the ESC key.

12.13 Last measurement results

The analyzer allows the viewing of the last measurement after a measurement is completed. In the main menu “Measurement” select the point “last meas. values”. The last values can be viewed, printed and/or saved.

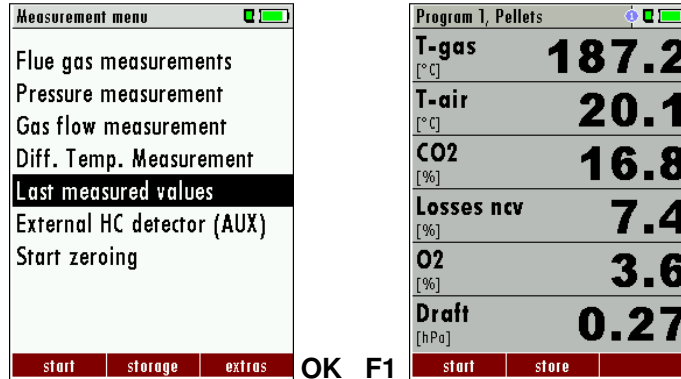

Above the F1 key “Start“instead of “Stop” is displayed. Pressing this key will continue the measurement.

12.14 Pressure measurement

Pressure (4 values) is measured and saved to the selected measurement name. The actual measured value is displayed in the middle of the display. The 4 measurement names can be changed as desired.

The hose on the draft + connector must be connected for draft measurements.

The second hose on the Delta P- connector must be connected for differential measurement.

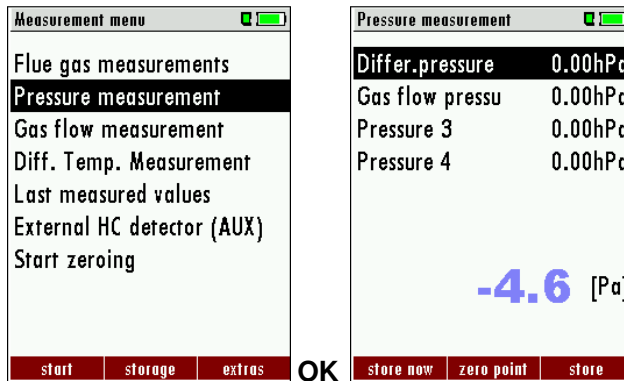

▲, ▼	Select the measurement name 1-4
F1	Save the measured value to one of the measurement name
F2	Zeroing the pressure sensor
F3	Change the name of the measurement category
ESC	Return to the measurement menu

12.15 Flow measurement (optional)

This option enables the measurement of the gas flow velocity in the flue gas duct or stack. The display shows flow rate [m/s]. **Connection of Pitot tube for flow velocity measurement.**

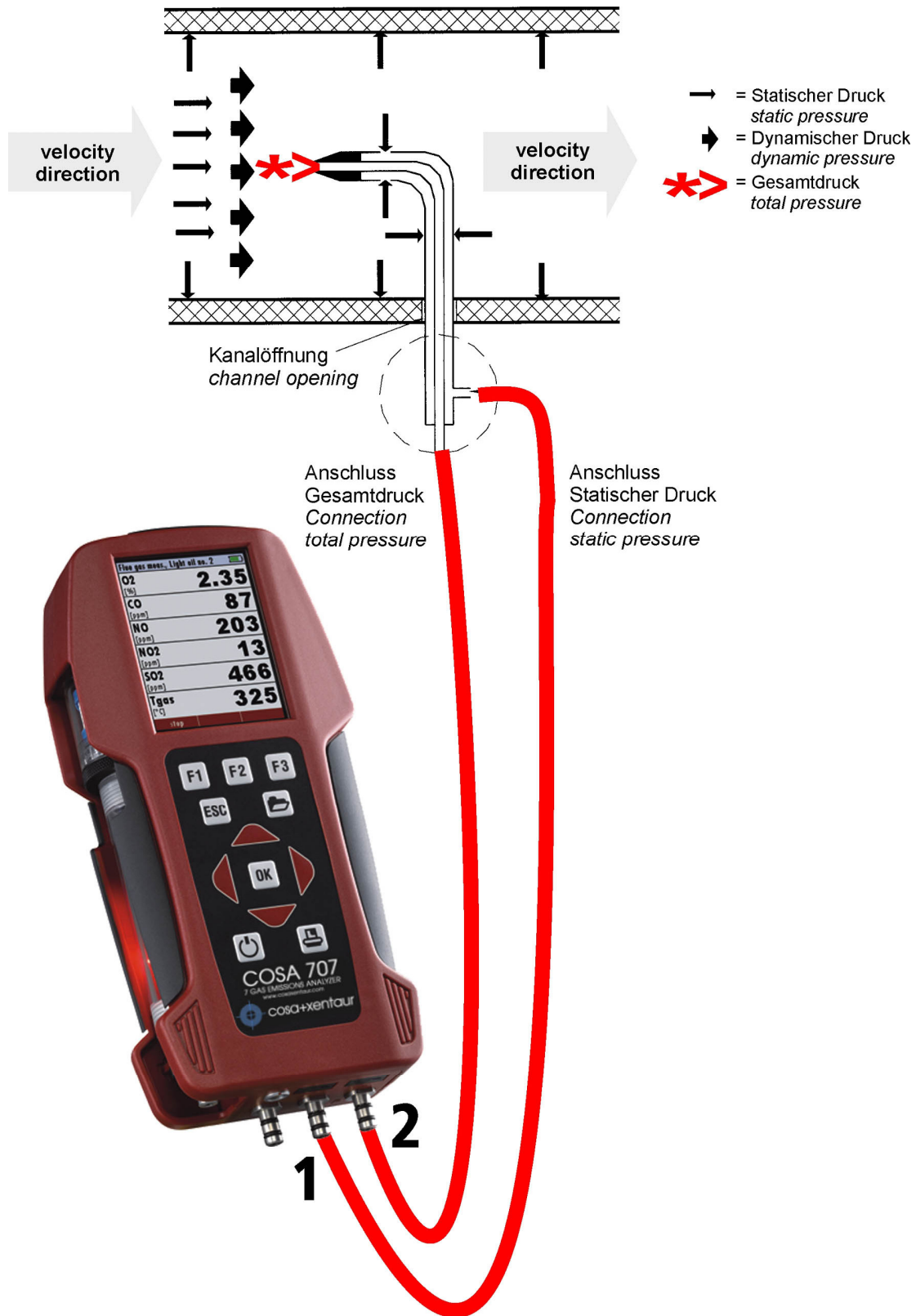



	change barometric pressure / area
F2	change units
F1	measurement START / STOP
F3	mode auto: automatic input of T gas (adoption measured T gas value)
PRINTER	print-out actual windows display
OK or ESC	back to measurement

The Pitot tube shaft is introduced perpendicularly in to the duct, by holes made in the surface, at selected positions.(see illustration).

The probe with the ellipsoidal nose is held parallel to and against the flow. The total pressure (+) collected by the nose is connected to the (+) connection on the COSA 707.

The static pressure (-) collected by the static pressure intakes in the probe is connected to the - connection on the COSA 707.

The COSA 707 will then indicate the dynamic pressure often called the velocity pressure.

The dynamic pressure corresponds to the difference between the total pressure and the static pressure.

P dyn. = P tot. + P stat.

The calculation of the gas flow velocity occurs by following formula:

$$v = 1,291 \sqrt{\frac{1000}{P_{\text{baro}} + P_{\text{stat}}} \times \frac{273,15 + T}{289} \times P_{\text{dyn}}}$$

Where :

P stat << P baro

v =	Gas velocity [m/s]
P baro =	barometric pressure [mbar]
T =	Temperature gas [°C]
P stat =	static pressure [Pa]
P dyn. =	dynamic pressure [Pa]

12.16 Differential temperature measurement

In the differential temperature measurement menu two temperatures can be measured simultaneously by using the T1 and T2 connectors. Both measured temperatures and the difference between the temperatures will be displayed.

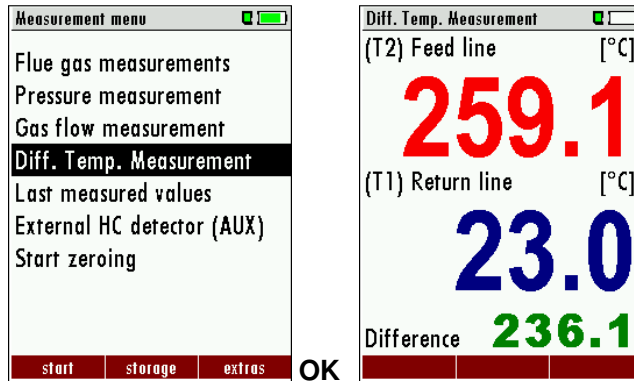

Note:

The accuracy of the difference temperature measurement is guaranteed only on use of the COSA temperature sensors.

12.17 External HC detector (optional)

The external HC-probe becomes at the AUX socket (4) COSA 707 connected and uses for the leakage detection

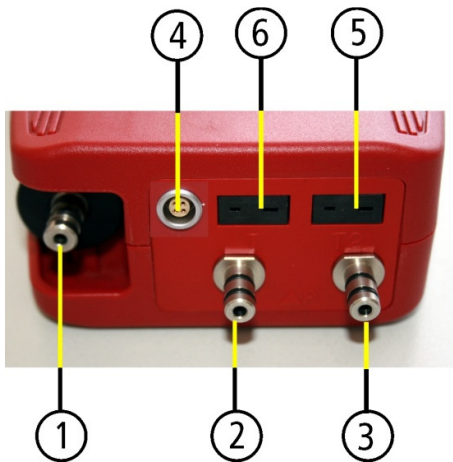

1	Sampling probe connection Condensate separator
2	Pressure connection 1 (Draft)
3	Pressure connection 2 (Differential pressure)
4	Connector AUX (optional)
5	Temperature connection 1 / T-Ambient air (combustion air)
6	Temperature connection 2 / T-gas

The red marking on the plug must agree with the red marking on the socket.

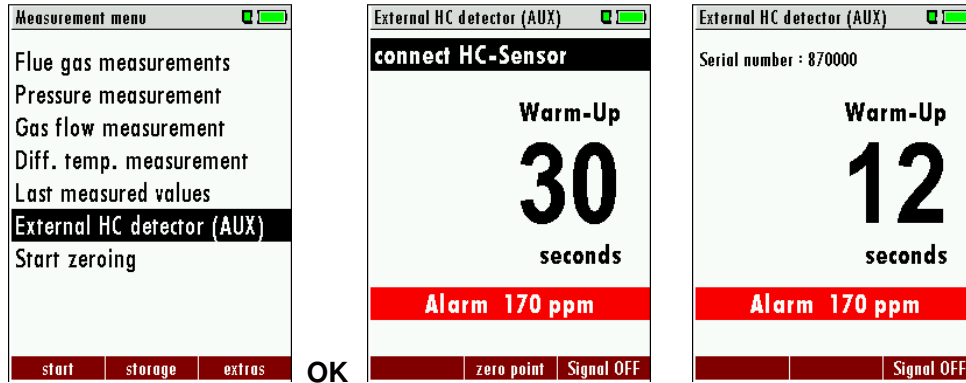

If the HC-probe is not yet connected to COSA 707 the flashing bar refers the connection „Connect HC-sensor “.

After the correct connection in place of the flashing bar the serial number of the HC-probe is indicated to the HC-probe.

During the warm-up phase (set to zero) the COSA 707 counts down from 30 to 0.

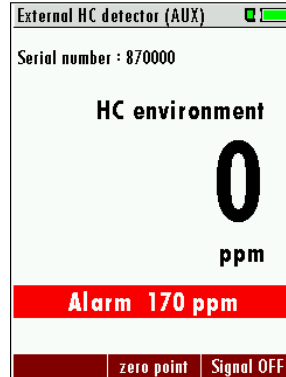

12.17.1 Operating HC-detection

Subsequently, the HC-probe is operational as HC detector.

With a HC-content over adjusted the alarm threshold in the environment the indicator value is represented in red, among them in black. During a HC-detection over 40 ppm (in the example) in the environment additionally an audio signal sounds to the red announcement.

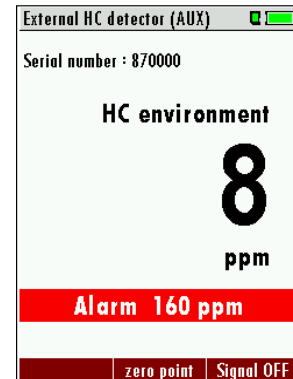
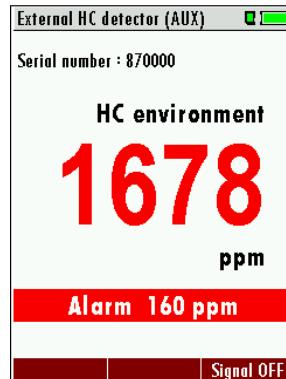

12.17.2 Setting alarm threshold and zero point setting

Change of alarm threshold and zero setting

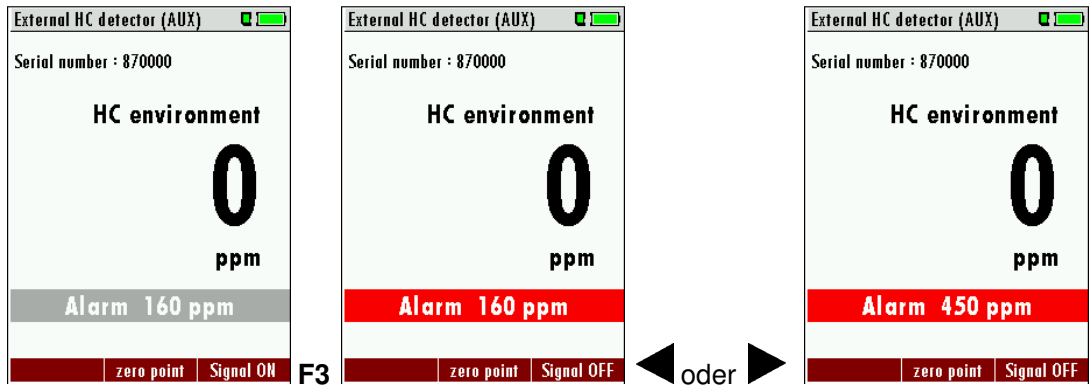

F2	Zero point setting
F3	Switch ON / OFF alarm treshold Bar grey deposits: Alarm threshold deactivates/alarm OFF Bar red deposits: Alarm threshold activates/alarm ON

12.17.3 Print-out

By pressing of the Printer – key the print-out of the current gas concentration is possible for COSA 707.

13 DATA STORAGE

13.1 Organisation of the data memory

Basis of the data memory of the COSA 707 is a set of sites stored in the device. Every site exists of an unique site number and 8 freely usable text lines which can have, e.g., the address, customer name etc.

The device can store up to 4000 different sites.

Sites can be created in the device and be changed, or could be imported from a PC program. Attention: sites created in the device and site data changed in the device will not be updated towards the PC. The device does only transmit to the PC the measurement values, but no information about site data.

Measurements are stored by assigning them to a site. Measurements can be, on this occasion, singles flue gas measurements or other measuring programmes available in the device.

13.2 Information about the data memory

In the menu item "storage" you select „memory info“ to get information about the actual memory volume. The part of free memory, the total number of the stored sites and the number of the measurements stored all together, split in the kind of the measurement is listed.

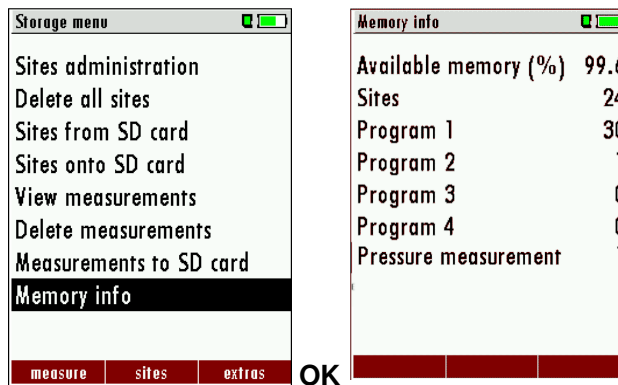

13.3 Site administration

In the menu item "Sites administration" you are able

- view all data of the stored sites
- create new sites
- change date of existing sites
- delete sites



Attention:

In the device new created sites and changes in the data of a site will not transmit to the PC back.

13.3.1 View and search sites

If the menu item "Site administration" will be selected for every stored site will be displayed with:

- of the unequivocal site number in the first line which is set down because of this meaning colorfully,
- the other 8 free text lines.

With the arrow keys on the left / on the right you scroll by all sites.

In this menu item, as well as in the menus for viewing the measurements, you can filter straight after sites by using a search mask.

- Select with the menu key "Search a site"

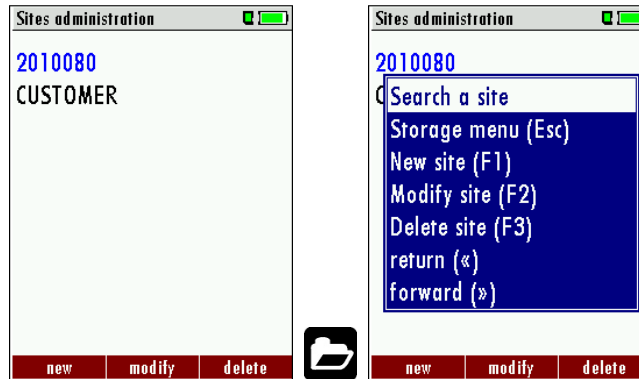

- Now you can enter the text to be searched for the first line, i.e. the site number, or for the second line, or for the rest of the text lines.

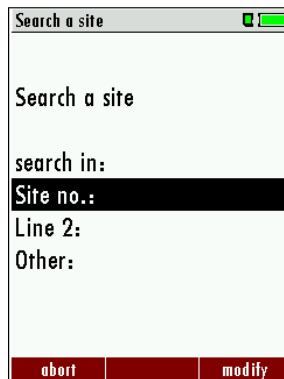

- Select the line for searching (site no. No., line 2, or rests) and select F3 "modify"
- Now in the indicated text input field you can enter a combination of letter, character and figures for whose occurrence is searched in the selected text field. Press then "OK".



- Select after input of the search text F2 = "start"

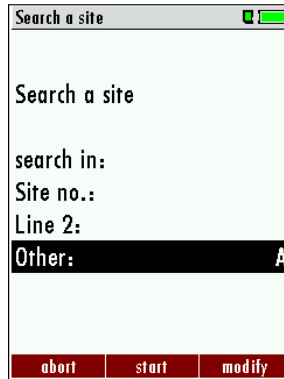

- If only one site is found as a result of the search, this is displayed. If became several sites the total number is found in the header viewed and you can scroll by this found standing with the arrow keys.

	Page through the sites
	Menu key: Search site ▲, ▼: Selection of the input field F3: Input mask, see chap. 16.1 F2: Start search ◀▶: According to the search criteria found sites page through. If no saved site with the search criteria agrees occurred the Medung: „Search unsuccessfully“
ESC	Back to storage menu

13.3.2 New entry and change of sites

In the menu item "Sites administration" you can new entry sites and change data of existing sites.

Select F1 = "new" for a new site. Besides, it is displayed:

- The first line which must contain an unequivocal site number to the identification of the site. With the function F2 = „auto no. “can assign the device automatically a free site number.
- All further free text lines which can contain, e.g., name and address.

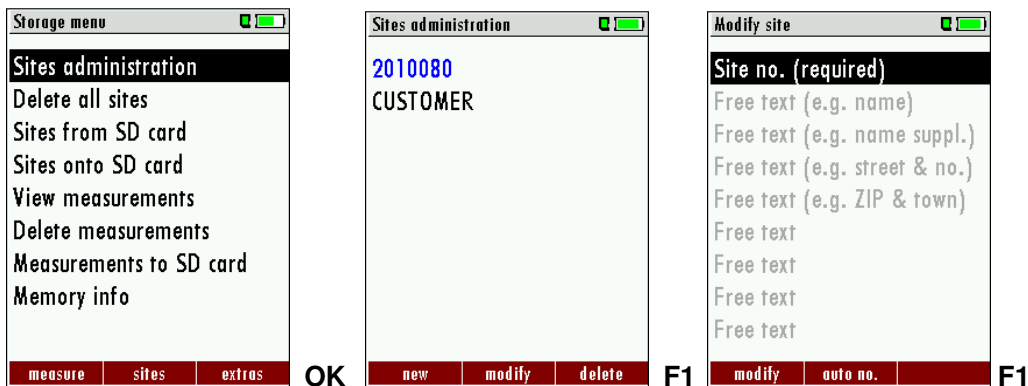

In the new site or an existing site you can change the data while you select the too change line, F1 = "modify" select and use the text input field for editing of the text. Conclude the text input field with "OK" and store the updates with F3 = "store".

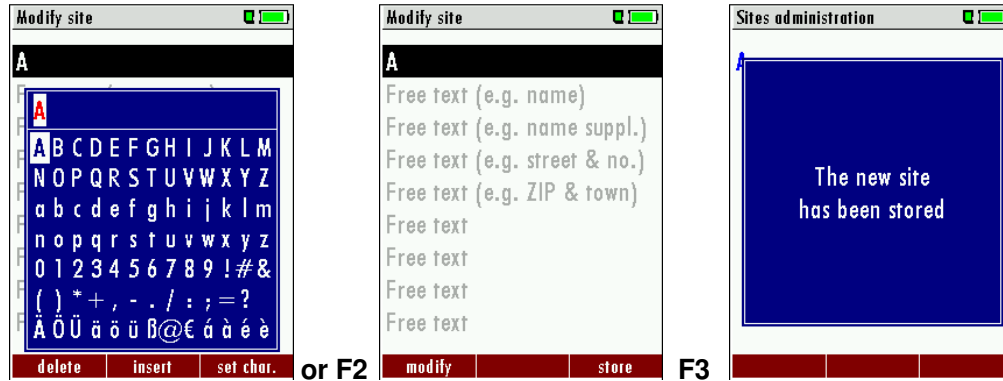

13.3.3 Delete sites

You are able to

- delete the displayed sites only by selecting the menu entry "F3" = "delete"
- or delete all sites at the same time

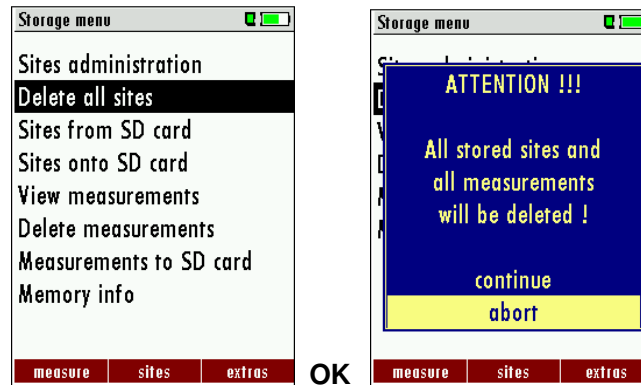

This user's decision must be confirmed. (see chap. 16.2).

13.4 Data transfer via SD Card (Option)

The data exchange format is CSV. A character-separated values (CSV) file is a simple text format for a database table. Each record in the table is one line of the text file. Each field value of a record is separated from the next by a character. COSA 707 uses a semi-colon ';' as value separator (other implementations use sometimes a comma). Implementations of CSV can often handle field values with embedded line breaks or separator characters by using quotation marks or escape sequences. CSV is a simple file format that is widely supported, so it is often used to move tabular data between different computer programs, for example Microsoft Excel™ or Access™, that support the format. Also other computer programs offer this type of interface because it is widely spread and easy to use.

The following functions are available from Software Version 1.11 and higher:

- Import of Sites
- Export of Sites
- Export of Flue Gas Measurements
- Export of Differential Pressure Measurements

13.4.1 Import of Sites

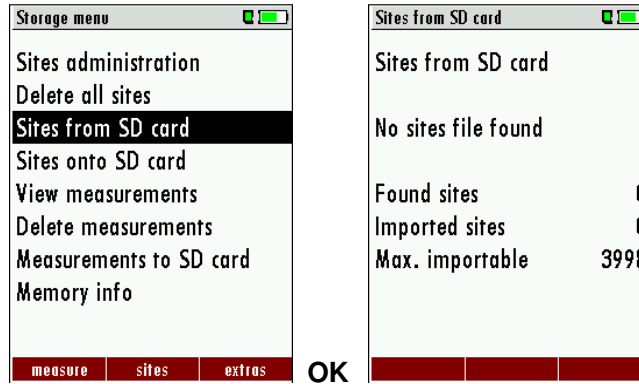

With this function you can Import Sites which have been created on a computer or another Analyzer.

The File name must have the name “anlagen.csv“ (anlagen = german for sites) . The file has no column heading that means that the first line already has user data. Each line has a minimum of 9 columns (with 8 semi-colons) and the first field in the line will be the site number. All data will be imported as long a site number is available. Per field a maximum of 24 characters will be imported, too long words will be cut off.

Example file with 8 valid sites (4 with 9 lines and 4 with less lines):

```
A1-Z1;A1-Z2;A1-Z3;A1-Z4;A1-Z5;A1-Z6;A1-Z7;A1-Z8;A1-Z9
A2-Z1;A2-Z2;A2-Z3;A2-Z4;A2-Z5;A2-Z6;A2-Z7;A2-Z8;A2-Z9
A3-Z1;A3-Z2;A3-Z3;A3-Z4;A3-Z5;A3-Z6;A3-Z7;A3-Z8;A3-Z9
A4-Z1;A4-Z2;A4-Z3;A4-Z4;A4-Z5;A4-Z6;A4-Z7;A4-Z8;A4-Z9
A5-Z1;A5-Z2;A5-Z3;A5-Z4;;;;;
A6-Z1;A6-Z2;;A6-Z4;;;;;
A7-Z1;;;A7-Z4;;;;;
A8-Z1;;;;;;;
```

Example file with 2 invalid sites (1 with not enough fields and 1 with missing site number):

```
A1-Z1;A1-Z2
;A1-Z2;A1-Z3;A1-Z4;A1-Z5;A1-Z6;A1-Z7;A1-Z8;A1-Z9
```

Important:

Whilst importing data from the SD Card to the analyzer there is no check for double site numbers (Line 1), neither inside of the file that is imported nor between the file and the sites already inside the analyzer. The analyzer can easily handle double site numbers but you could face problems with double site numbers when exporting them again to a computer program (see also Export of Measurements).

However the analyzer marks the files that have been imported successfully. If you try to import a file with the same analyzer that is already in the analyzer you will get a red information screen.

13.4.2 Export of Sites

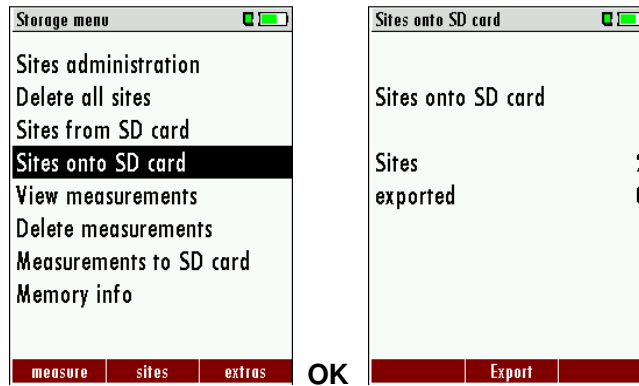

This function can be used for an analyzer back up or if you wish to supply the analyzer information to a computer program or another analyzer. This is very handy if you have made some modifications inside the analyzer (site) for example if you have modified the phone number of a customer and this modification needs to be updated in the computer software, or if a second analyzer needs to have the same site information.

The File format ist the same as described above, „Import of Sites“.

Only the file name is different, the file name will be ‚ANLxxxx.csv‘, in which the xxxxx are continuing 5 digit numbers with leading zeros. If the file must be imported into another analyzer, the file must first be renamed into „anlagen.csv“.

13.4.3 Export of Flue Gas Measurements

This function is used to export the measurements from the analyzer to a computer program.

Attention! This function is not suitable for back up or for the transfer to another analyzer because the exported file can not be imported again!

The created file has the name ‚EMlxxxx.csv‘, in which the xxxxx are continuing 5 digit numbers with leading zeros.

The created file has a column header with the following information: Site number, Date/Time, Measuring program name, Fuel type, CO2max, O2reference, and all measured values that the analyzer can measure as well as the soot numbers, Derivate and T-Boiler.

Example:

	A	B	C	D	E	F	G	H	I	J	K
1	Site no.	Date & time	meas.progra	fuel type	CO2max [%]	O2ref [%]	T-gas [°F]	T-air [°F]	Dewpoint [°F]	O2 [%]	CO2 [%]
2	BOILER	THU 30.09.20	Program 1	Natural gas	11.7	3.0	--.	73.5	--.	21.0	--.
3	BOILER	THU 30.09.20	Program 1	Natural gas	11.7	3.0	--.	73.0	--.	21.0	--.
4	BOILER	THU 30.09.20	Program 1	Natural gas	11.7	3.0	--.	73.0	--.	21.0	--.
5	BOILER	THU 30.09.20	Program 1	Natural gas	11.7	3.0	--.	72.5	--.	21.0	--.
6	BOILER	FRI 01.10.20	Program 1	Natural gas	11.7	3.0	--.	72.5	--.	21.0	--.
7	A FURNACE	TUE 05.10.20	Program 1	Natural gas	11.7	3.0	81.0	--.	113.0	11.7	5.2
8	A FURNACE	TUE 05.10.20	Program 1	Natural gas	11.7	3.0	81.0	--.	113.0	11.7	5.2
9	A FURNACE	TUE 05.10.20	Program 1	Natural gas	11.7	3.0	82.5	--.	112.5	11.7	5.1
10	A FURNACE	TUE 12.10.20	Program 1	Natural gas	11.7	3.0	84.5	--.	132.5	2.7	10.2

13.4.4 Export of Differential Pressure Measurements

The same function as under 13.4.3(Export of Flue Gas Measurements) only the file name is different.

The created file has the file name „DDMxxxx.csv“, in which the xxxxx are continuing 5 digit numbers with leading zeros.

The created file has a column header with the following information: Site number, Date/Time, as well as 4 saved pressure measurements.

13.5 Measurements in the data memory

13.5.1 View measurements

In the menu item „View measurements“ you can inspect the stored measurements. After selection of this item you receive first an overview of the number of the stored measurements according to measuring type.

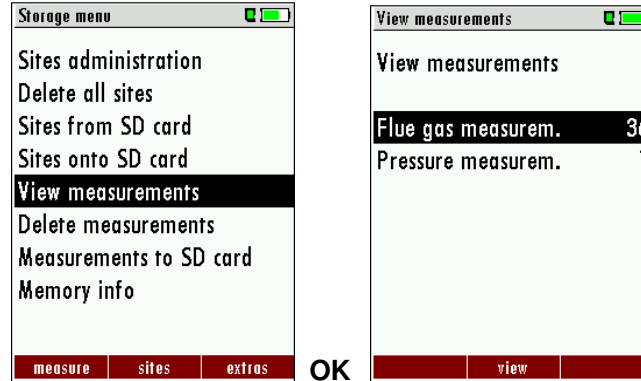

- Select flue gas measurement or another measuring type.
- Then you receive first a page with context information to the stored measurement. Scroll with the arrow keys by the context information of the stored measurements.



- With F2 = "measured value" are displayed the measured data of the stored measurement in detail, available in 3 measuring value pages, as they are defined in the measuring value window.

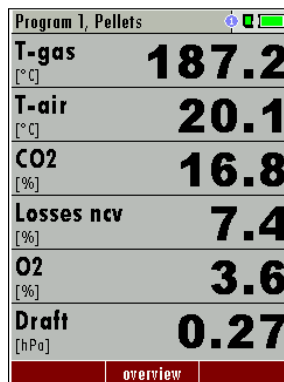

- With ESC you return to the context information of the measurement.

You have the possibility to display only those data that are assigned to a single site.:

- either F1 = „this site“ , while a measurement of the desired site is displayed. With F1 = „all sites“ you cancel this filter again.

- or while you select with the menu key the function "search a site" and execute, as described in the chapter site administration.

13.5.2 Delete measurements

You are able to

- delete single measurements, while they are displayed – press the key F3 = "delete".
- or delete all measurements of a measuring type.

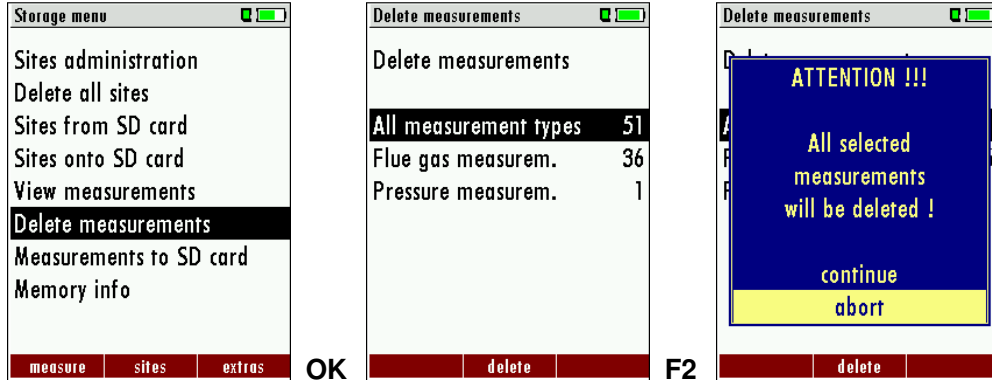

13.5.3 Export measurements to a SD card (optional)

The COSA 707 offers the possibility to export all stored measurements to a SD card.

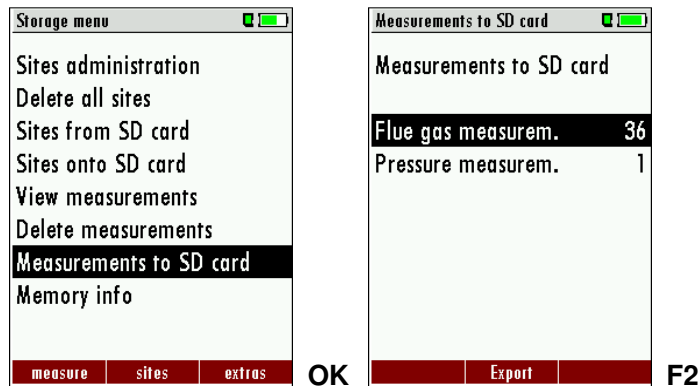

By confirming with the F2 key the data transmission / export on the SD card is started.

During the data export the display reads „please wait”. A write error to SD card is reported by the instrument. Make sure that the SD card is not write protected.

The data are stored as a csv-file (e.g., EMI01032.csv) on the SD card. The filename exists of a sequential number which fixes the device.

This file is editable on your Notebook/PC with a program like e.g. Microsoft® EXCEL or OpenOffice® Calc.

With possible problems with the using of your computer programs please read your software documentations or ask your software dealer.

14 EXTRAS / ADJUSTMENTS

The COSA 707 is delivered in a standard software configuration which should cover most needs. However, there are many ways to tailor the settings to your individual needs if required. The possibilities are highly flexible and individual adaptable.

Use the variable possibilities to adapt your analyzer to your own needs and customize the measurement menu, the measurement window, the printer out put and many other features. Usually this is something you will do once you receive the analyzer, once you have adapted your analyzer you will most probably don't make much changes in future, but you can when ever you need and want to do so.

After you have made any changes in the configuration, you should switch off the analyzer to save all the changes that have been made. Next time that you start up the analyzer, all changes will have been made.

14.1 Maintenance adjustment menu

The Maintenance adjustment menu is secured with a Pin Code to protect it against unauthorized users.

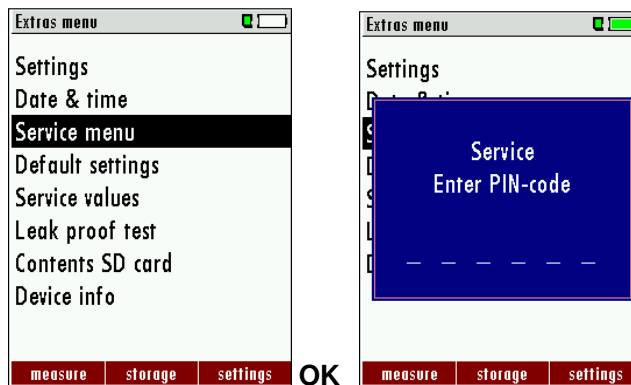

If you enter a wrong pin code you will be exited into the “Extra Menu” again.

Please contact COSA if you need the Pin Code for your analyzer.

Press the Enter key if you should have landed in this menu by accident and you will be exited into the “Extra Menu” again.

14.2 Manufacturer default settings

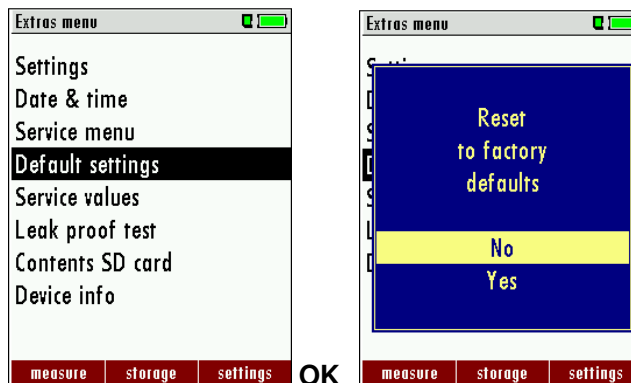

The analyzer will be reset to original delivery settings.

Be aware that your configurations will be deleted, such as:

- CO-ppm limits
- Fuel type list activation
- Measurement window selection and others.

14.3 Service values

Should your analyzer display an error message after zeroing (for example: „O2-Sensor not OK“), then you can use the Service value menu to get detailed information about possible defects. In this menu you will see all service values of the sensors and also other parameters.

In case of a defect contact the Cosa service department. The Cosa service technician will ask you about these values or he will ask you to send them by fax or email.

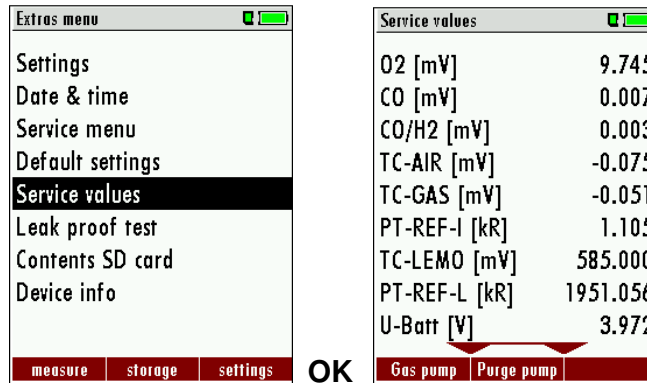

▲, ▼	Jump between the lines
F1	Function test gas pump (on / off)
F2	Function test purge pump (on / off)
ESC	return

14.4 Leak proof test

With the leak proof test the system is checked by the device (incl. the condensate separator) up to the probe spike on undensity. The internal gas pump generates in addition a subpressure which is measured over the built-in draft sensor and is observed for a period of 10 seconds. Based on the decrease of pressure the leakness of the system will be determined.

Operation:

- The leak proof test cap # 61382 (for probe tubes Ø 8 mm) must be put on on the probe spike.



ATTENTION:

The probe spike before the density test clean!
(With depositions on the tube the cap does not seal.)

- Launch under “extras” the leak proof test on which the following window will pop up:



If of the leak proof test is not passed the probe must be checked including the hosing as well as the condensate separator.

If no undensity is ascertained in these external parts the COSA 707 Combustion Analyzer has to be checked in a service department (worldwide service departments see www.cosaxentaur.com).

14.5 Contents SD card

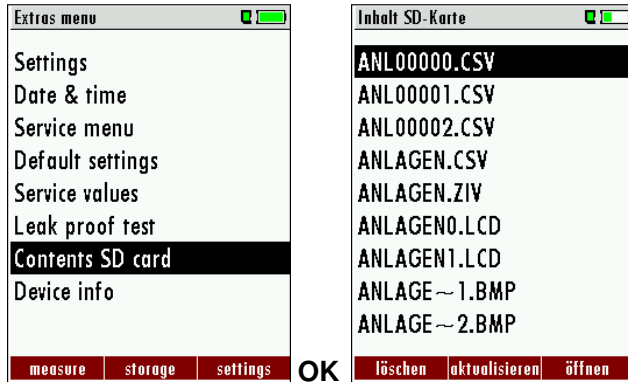

The contents of the SD card will be displayed. With F3 the selected file can be opened.

14.6 Analyzer info

Here you will find information about the analyzer and the installed options.

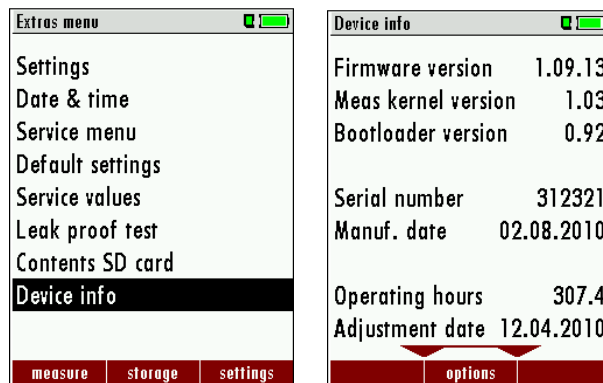

Press the F2-key to see the installed options.

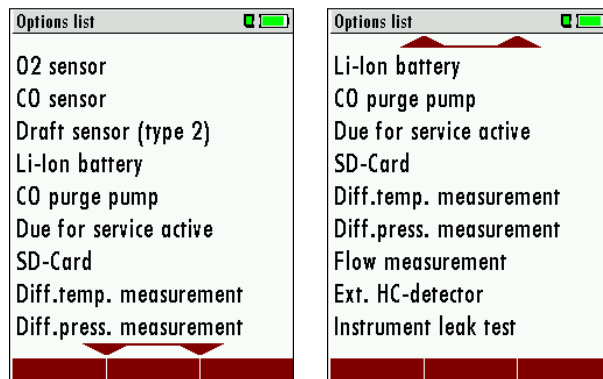

With the F1-key you get information about the date of the last 7 service procedures

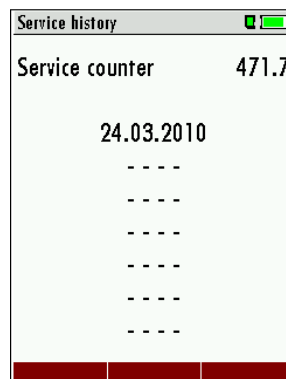

15 TECHNICAL SPECIFICATIONS

Measured values

COSA 707

Electro chemical sensors

O₂

Measurement range	0 - 21,0 Vol-%
Accuracy	± 0,2 Vol-% absolute
Reaction time T90*	< 20 sec

CO (H₂ comp.) (optional # 63132)

Measurement range	0 - 4.000 ppm, overload up to 10.000 ppm
Accuracy	± 10 ppm or** 5 % of the measured value up to 4.000 ppm or** 10 % of the measured value up to 10.000 ppm
Reaction time T90*	< 40 sec

CO low (optional # 63133)

Measurement range	0 - 300 ppm, with 0,1 ppm resolution
Accuracy	± 2,0 ppm or ** 5 % reading

CO high (optional # 63057)

Measurement range	0 - 4.000 ppm, overload up to 20.000 ppm
Accuracy	± 100 ppm or** 5 % of the measured value up to 4.000 ppm or** 10 % of the measured value up to 20.000 ppm
Reaction time T90*	< 40 sec

CO very high (optional # 63134)

Measurement range	0 – 4,0 %, overload up to 20.000 ppm
Accuracy	± 0,02 or** 5 % of the measured value up to 4,00 % or** 10 % of the measured value up to 20.000 ppm
Reaction time T90*	< 40 sec

NO (optional # 63058)

Measurement range	0 - 1.000 ppm, overload up to 5.000 ppm
Accuracy	± 5 ppm or** 5 % of the measured value up to 1.000 ppm or** 10 % of the measured value up to 5.000 ppm
Reaction time T90*	≤ 30 sec

NO low (optional # 63135)

Measurement range	0 - 300 ppm, with 0,1 ppm resolution
Accuracy	± 2,0 ppm or ** 5 % reading

NO₂ (optional # 63059)

Measurement range	0 - 200 ppm, overload up to 1.000 ppm
Accuracy	± 5 ppm or** 5 % of the measured value up to 200 ppm or** 10 % of the measured value up to 1.000 ppm
Reaction time T90*	≤ 60 sec

SO₂ (optional # 63060)

Measurement range	0 – 2.000 ppm, overload up to 5.000 ppm
Accuracy	± 10 ppm or** 5 % of the measured value up to 2.000 ppm or** 10 % of the measured value up to 5.000 ppm
Reaction time T90*	≤ 40 sec

* for SHORT-Term measurements only

** which ever is larger!

Flue gas temperature T_A

Measurement range 0 - 650 °C with high grade steel probe pipe
 Measurement range 0 - 1.100 °C with Inconel probe pipe
 Accuracy ± 2 °C ≤ 200 °C
 1 % of the measured value > 200 °C

Ambient air temperature T_L

Measurement range 0 - 100 °C
 Accuracy ± 1 °C

Draft

Measurement range ± 200 hPa
 Accuracy ± 0,02 hPa or** 1% of the measured value

Differential pressure

Measurement range ± 100 hPa
 Accuracy ± 0,02 hPa or** 1% of the measured value

Vacuum pressure range gas pump

150 hPa
 (Fuel type dependent)

Calculated values

CO₂
 Measurement range 0 - CO₂ max
 Accuracy ± 0,3 Vol-% absolut

Dew point

°C
 0 - 99,9 %
 0 - 120 %

Losses q_A

Efficiency η

Measurement values as

General specification

mg/Nm³, O₂ in relation, mg/KWh, NO_x as mg/Nm³ NO₂
 + 5 - + 45 °C / +41 ... + 113° F, max. 95 % RH, not condens-
 ing
 - 20 - + 50 °C / - 4 ... + 122° F

Internal: NiMH battery pack 3,6 V/ 2.100 mAh, 6 h operation
 time

Power supply
 Internal: LI-Ion battery pack 3,6 V/ 4.900 mAh (optional), 15 h
 operation time

External
 wall-plug grid power supply, 100 - 240 V AC / 5,0 Vdc / 1200
 mA / 50 ... 60 Hz

Weight
 ca. 750 g / approx. 1.65 lbs (with 2 sensors)

Sizes
 244 x 113 x 54 mm / 4.3" x 8.8" x 2.04"

* = typical sensor value

**Technical changes possible at any
 time!**

Rev date: 20.12.2010

16 APPENDIX

16.1 Text input

A numbers of texts and names can be changed to your own needs.
 (for example: the names of the user defined fuel types, site names, the names of the measurement programs)

When you select the text input, the following window will pop up:

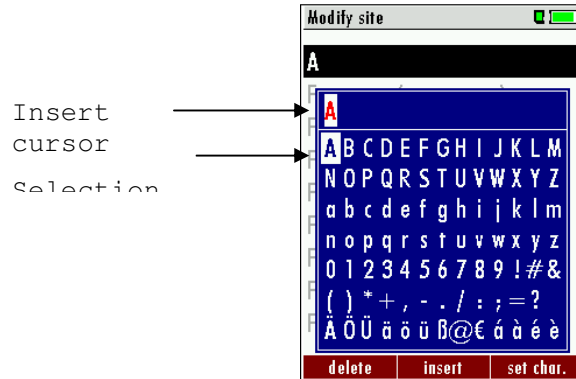

▲, ▼, ◀, ▶	Select a letter, number or sign
F1 – delete	The letter left of the cursor will be deleted
F2 – insert	Selected letter or number will be inserted
F3 – over write	Selected letter or number will over write the current letter or number
ESC	Abort the window, changes will NOT be saved

16.2 Asking the user for a decision (pop up window)

The COSA 707 will ask you now and then to confirm the action that will be taken.

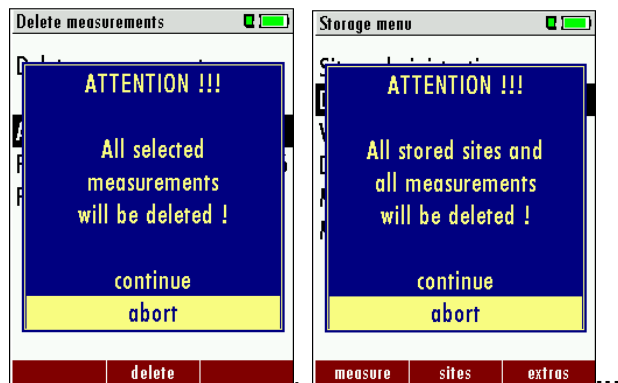

▲, ▼	Select a line
OK	Confirm the action
ESC	Abort the window, changes will NOT be saved

16.3 Datatransfer with Bluetooth (optional)

16.3.1 PDA-interface Bluetooth

With the Bluetoothmodul it is possible to transfer measured values from a Cosa measuring instrument wirelessly to one bluetooth to capable pocket PC.

The option Bluetooth makes the remote control possible of the Cosa measuring instrument.

By the pocket PC different functions can be implemented like a starting or a terminating of fuel-, CO, annular gap or course measurements.

Resuming documentations are attached to the option Bluetooth, and take you from your pocket PC manual and/or the documentation of your Bluetooth adapter.

In addition the enclosed software Cosa Connect is necessary at the pocket PC.

If OnlineView or MRUConnect (PDA) is used over Bluetooth, you scolded the SLAVE mode. That auto connect mode must be switched OUT.

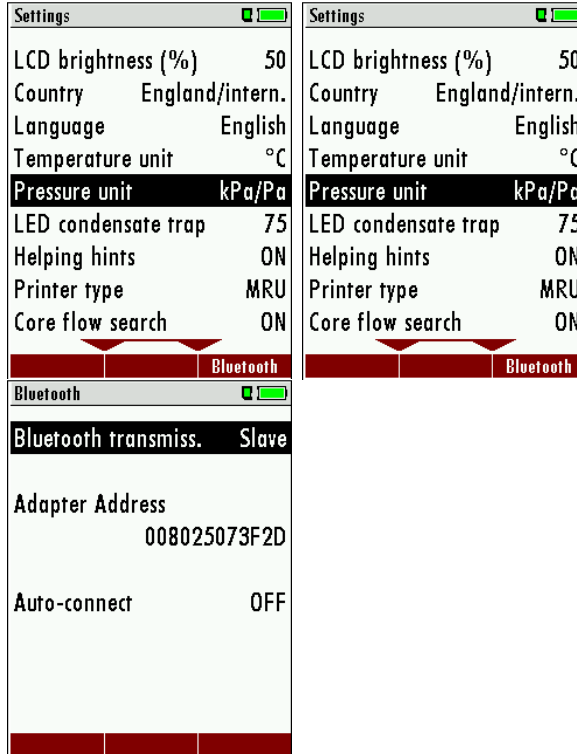

16.3.2 PC-interface Bluetooth

As PC operating system is Windows XP with service pack 2 or more highly necessarily.

If OnlineView or MRUConnect (PDA) is used over Bluetooth, you scolded the SLAVE mode. That auto connect mode must be switched OUT. The PC must be MASTER-mode.

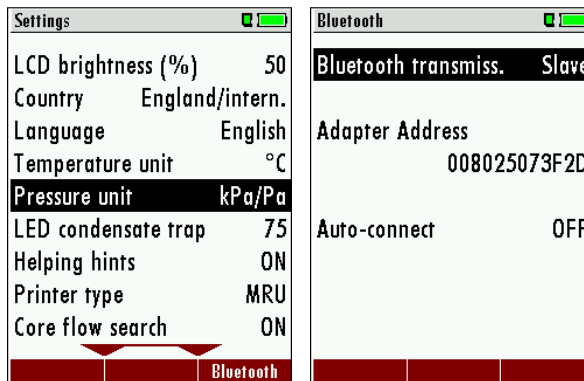

16.3.3 Spezifikation

Bluetooth Class 2

Range: up to 10 Meter

Type-description: +B20

Bluetooth listing identifier: B011904

Option Bluetooth® Certification

EU countries

Belgium (BE), Bulgaria (BG), Denmark (DK), Germany (DE), Estonia (EE), Finland (FI), France (FR), Greece (GR), Ireland (IE), Italy (IT), Latvia (LV), Lithuania (LT), Luxembourg (LU), Malta (MT), Netherlands (NL), Austria (AT), Poland (PL), Portugal (PT), Romania (RO), Sweden (SE), Slovakia (SK), Slovenia (SI), Spain (ES), Czech, Republic (CZ), Hungary (HU), United Kingdom (GB) and Republic of Cyprus (CY).

Other EFTA Countries

Iceland, Liechtenstein, Norway and Switzerland

Non-european countries

Japan, Columbia, Turkey

16.4 Using the USB-Port

This port is used for data transfer from your analyzer to your PC / Laptop using the MRU Online View (Version 2.XX). The first time you want to use your analyzer for data transfer to your PC or laptop, you have to “mate” the COSA 707 and your PC / Laptop. (Requires operating system Windows XP or Windows 7).

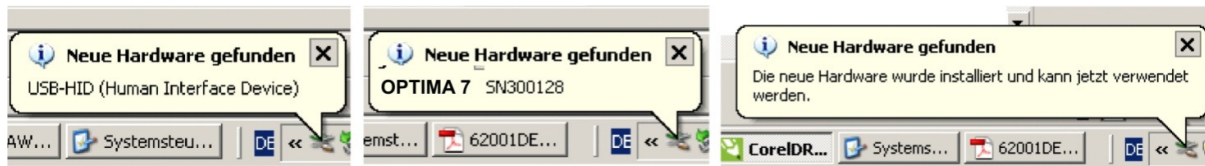

Your PC / Laptop will recognize the COSA 707 as USB- HID (Human Interface Device).

Check list:

1. Switch on the COSA 707
2. Connect the USB cable to the COSA 707
3. Connect the USB cable into a free USB port at your PC/Laptop
4. The PC/Laptop must be powered on
5. The above seen information „New hardware found“ will be displayed above the USB-Icon of your PC/Laptop

If this is not the case, then you have a problem with your USB-Connection of your PC/Laptop.

Check in your Device Manager if the analyzer is ready for operation.
The COSA 707 is as HID-conform unit registered.

Windows XP: Press the START button – then select the CONTROL PANEL – select SYSTEM – selct HARDWARE – select DEVICE MANAGER

Windows 7: for Windows 7 there are several possibilities, please read below and/or your Windows 7 manual for details.

For Windows XP:

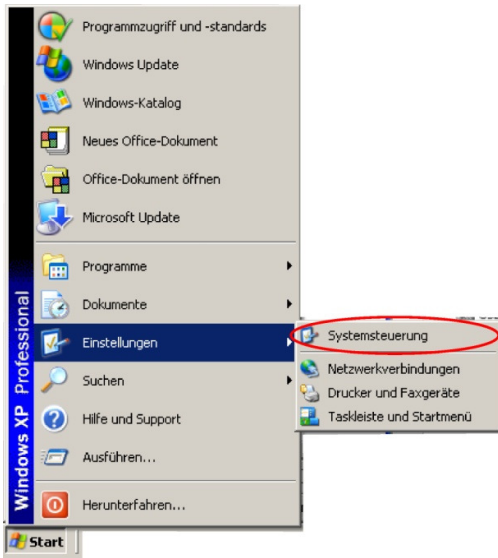

(The graphics may look different on your PC/Laptop as shown in this manual!!)

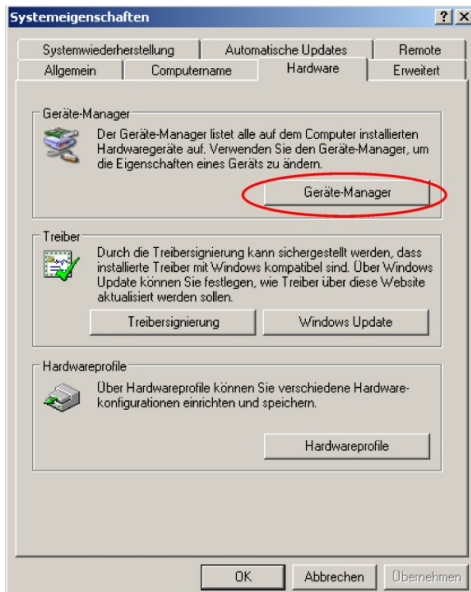

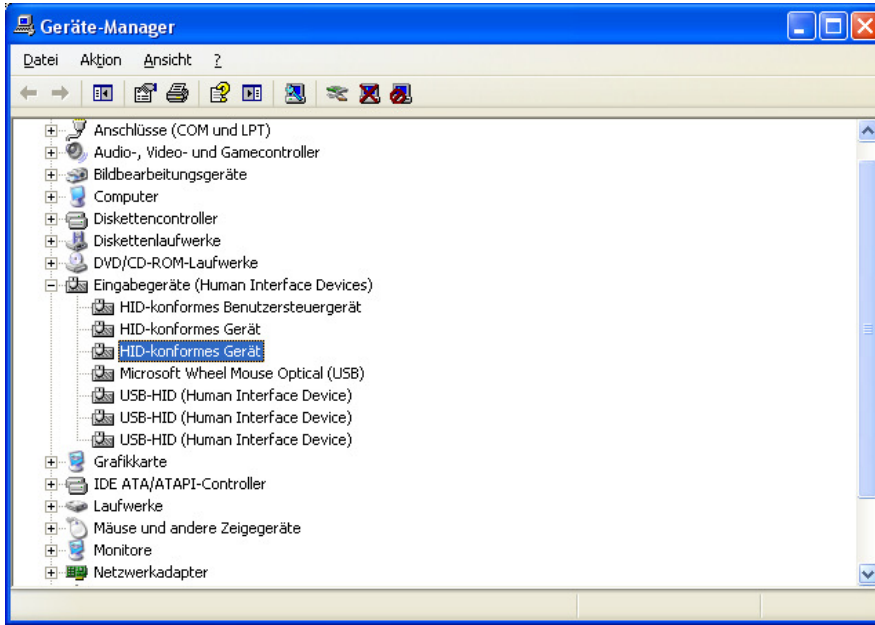

The COSA 707 is registered as HID-compliant device.

In the General folder you can see if the unit is ready for operation.

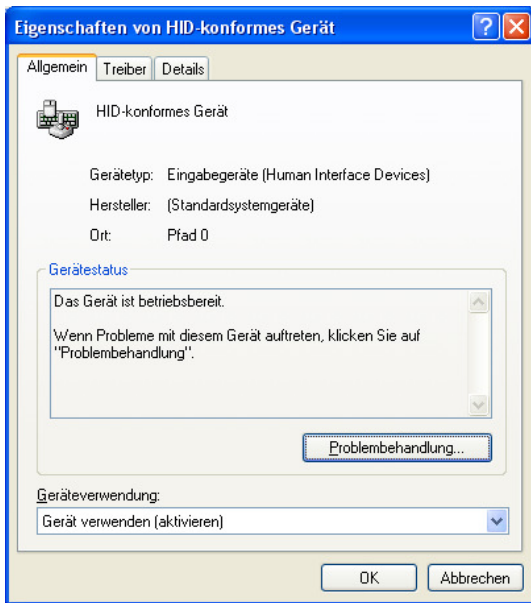

In the Detail folder the unit is registered with the VID 152A.

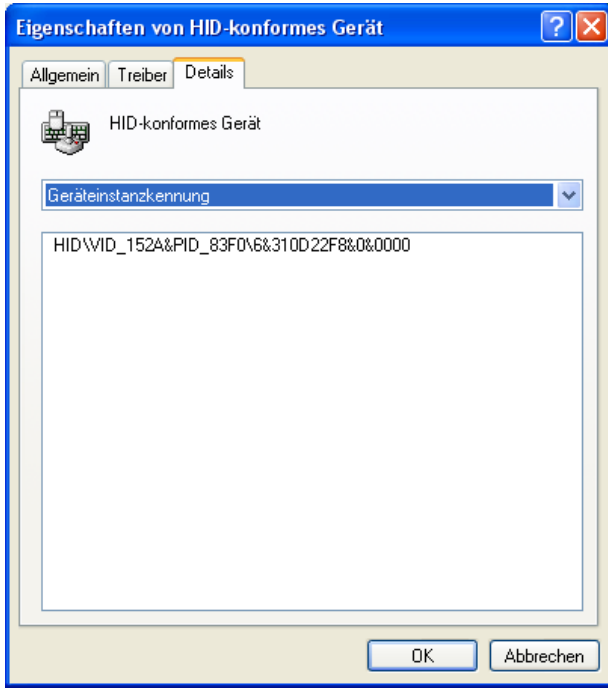

In case the analyzer id not ready for operation, choose a different USB instrument to check the USB port on your computer, and/or connect the COSA 707 to a different computer to locate the error.

WINDOWS 7:

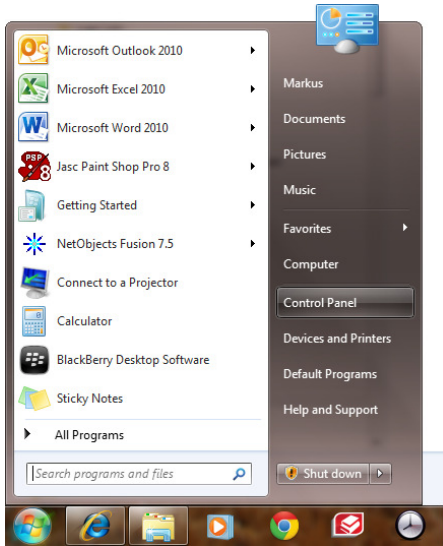

Press the STRAT LOGO and then select CONTROL PANEL.

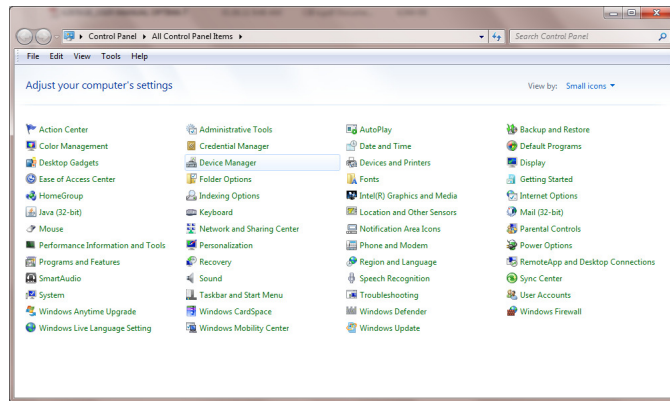

Select the Device Manager

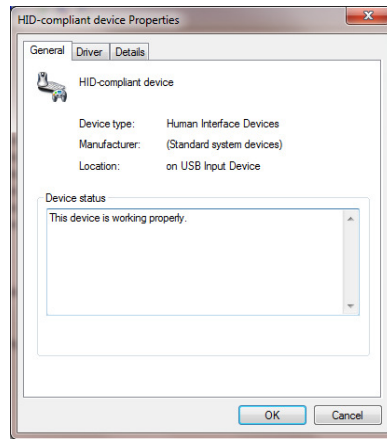
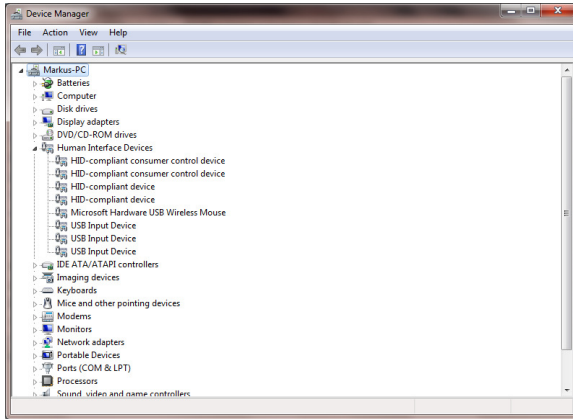

The COSA 707 is registered as HID-compliant device.

In the General folder you can see if the unit is ready for operation.

16.5 Analysis and calculations

Measured values	Unit
O ₂	[%]
CO ₂ (optional)	[%]
CO	[ppm]
CO	[%]
NO	[ppm]
NO ₂	[ppm]
SO ₂	[ppm]
Temp. Ambient air (Thermo-Element)	[°C] [°F]
Temp. Flue gas (Thermo-Element)	[°C] [°F]
CO	[ppm]
Draft	[hPa]/cf. Chapter 9.2

Available conversions of CO	CO
[ppm] related to. on 0% rest O ₂ (undiluted)	X
[ppm] related to. on fuel type dependent O ₂ reference value	X
[mg/m ³]	X
[mg/kWh]	X
[mg/MJ]	X
[mg/m ³] on fuel type dependent O ₂ reference value	X

Continuously caculated values	Unit
CO ₂	[%]
Efficiency ETA	[%]
Efficiency condensed	[%]
Losses	[%]
Losses condensed	[%]
Lambda	-
Dew point	[°C] [°F]

Losses and efficiency are calculated by means of net calorific value. These values are than referenced for the gross calorific value for condensing boilers only. (efficiency > 100)

The calculations of efficiency and exhaust losses are performed using Siegert’s formula.

For further information please contact COSA. (www.cosaxentaur.com)

16.6 EG –Declaration of confirmity

On Request

Technical data change w/o notice!

Date of issue: 20110524